

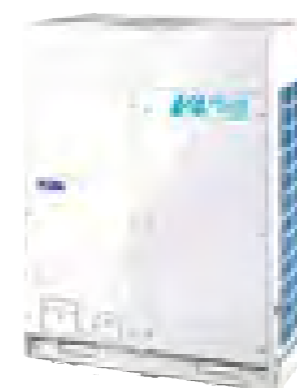

2016

Commercial Air Conditioners



VRF 60Hz
V4+S/V4+R/V4+W/Mini VRF



INDOOR UNIT LINEUP

kW		1.8	2.2	2.8	3.6	4.5	5.6	7.1	8.0	9.0	10.0	11.2	12.5	14.0	16.0	20.0	25.0	28.0	40.0	45.0					
Btu/h		6k	7k	9k	12k	15k	19k	24k	27k	30k	34k	38k	42k	48k	55k	68k	85k	96k	136k	154k					
Cassette	One-way cassette	■																							
	Two-way cassette		■																						
	Four-way cassette			■																					
	Compact four-way cassette		■																						
Duct	Low static pressure	■																							
	Medium static pressure		■																						
	High static pressure								■																
	Fresh air processing unit													■			■								
Wall mounted		■																							
Ceiling & floor				■																					

Notes:
Fresh air processing unit is not available for V4+R and Mini VRF Series.



» OUTDOOR UNITS VRF V4 PLUS SYSTEM

-  **Indoor Units**
VRF V4 Plus indoor units
-  **Fresh Air Processing Unit**
100% fresh air supply
-  **Ventilation**
Heat recovery ventilator (HRV)
-  **AHU Connection Kit**
Connect to other brand AHU
-  **Control Systems**
Smart control systems



VRF V4 Plus S Series Heat Pump

Optimized design
for small to large
buildings

- » ALL DC inverter compressors
- » ALL DC fan motors
- » Capacity up to 72HP
- » Connectable indoor units quantity up to 64
- » ESP up to 60Pa
- » Cycle duty operation
- » Backup operation
- » Precise oil control technology
- » Advanced silence technology
- » Intelligent defrosting technology
- » Simple communication wiring
- » Auto addressing
- » Easy maintenance

High EER and COP Values »

V4 Plus S Series equipped with all DC compressors, all DC fan motors and high efficient heat exchanger. The cooling EER is up to 4.29 and the heating COP is up to 4.39 in the 8HP category.

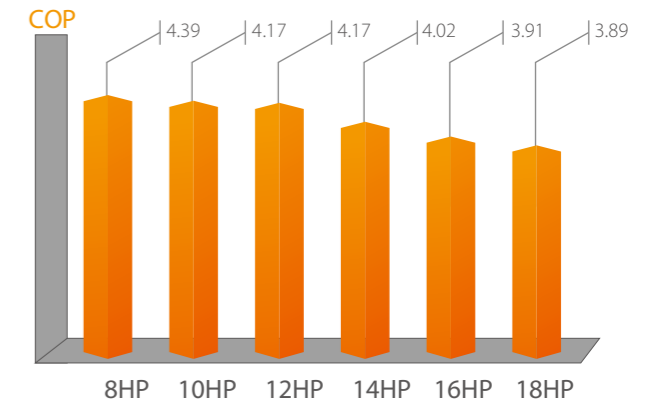
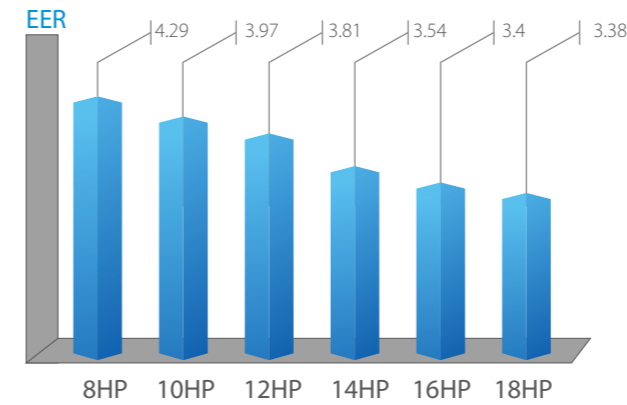

Long Piping Length »

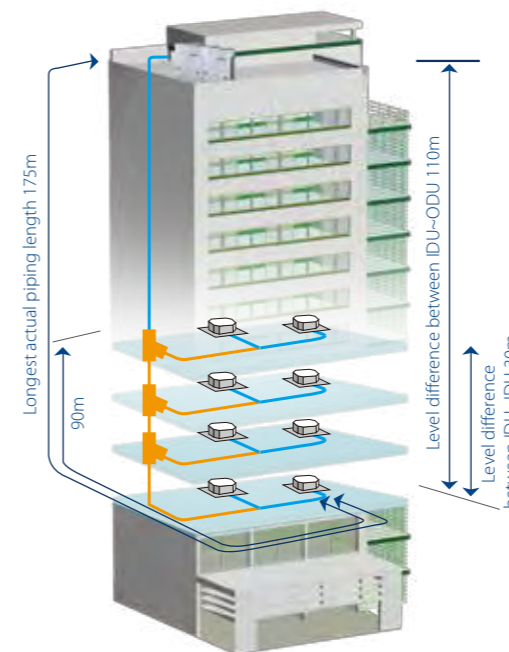

Total piping length	1000m	3280ft.
Longest length actual (Equivalent)	175(200)m	574(656)ft.
Longest length after first branch	90*m	295*ft.
Level difference between indoor and outdoor units - ODU up (down)	70(110)m	230(361)ft.
Level difference between indoor units	30m	98ft.

*The longest piping length is 40m(131ft.) standard. It can be extended to 90m(295ft.). When the length is over 40m(131ft.), please contact your local TGM dealer for more information and restrictions.

VRF V4 Plus S Series - Heat Pump

380~415V-60Hz / 220V-60Hz



HP	380~415V		50	52	54
Model MDV-	1400(50)W/D2CN1(B)		1450(52)W/D2CN1(B)	1500(54)W/D2CN1(B)	
Model MDV-	1400(50)W/D2DN1(B)		1450(52)W/D2DN1(B)		1500(54)W/D2DN1(B)
Combined type	14HP+18HPx2		16HP+18HPx2		18HPx3
Power supply	V/Ph/Hz		380-415/3/60 & 220/3/60		
Cooling	Capacity	kW	140.0	145.0	150.0
		kBtu/h	477.7	494.7	511.8
	Power input	kW	40.89	42.82	44.38
	EER		3.42	3.39	3.38
Heating	Capacity	kW	157.0	162.0	168.0
		kBtu/h	535.7	552.7	573.2
	Power input	kW	39.99	41.58	43.19
	COP		3.93	3.90	3.89
Connectable indoor unit	50~130% of outdoor unit capacity				
Compressor	Total capacity		64		
	Max. quantity		6		
	Type		DC inverter		
Fan motor	Quantity		6		
	Type		DC motor		
	Quantity		6		
Refrigerant	Type		R410A		
	Factory charging (380~415V)	kg(lbs.)	15+16x2(33+35x2)	15+16x2(33+35x2)	16x3(35x3)
	Factory charging (220V)	kg(lbs.)	13+16x2(29+35x2)	13+16x2(29+35x2)	16x3(35x3)
Pipe connections	Liquid pipe	mm(in.)	Φ22.2(Φ7/8)		
	Gas pipe	mm(in.)	Φ41.3(Φ1-5/8)		
	Oil balance pipe	mm(in.)	Φ6(Φ1/4)		
	Air flow rate	m ³ /h	15620x3		
Sound pressure level	dB(A)	66			
Net dimension (WxHxD)	mm	(1250x1615x765)x3			
Packing size (WxHxD)	mm	(1305x1790x820)x3			
Net weight	380~415V	kg(lbs.)	288+310x2(634+682x2)	288+310x2(634+682x2)	310x3(682x3)
	220V	kg(lbs.)	285+310x2(627+682x2)	288+310x2(634+682x2)	310x3(682x3)
Gross weight	380~415V	kg(lbs.)	308+330x2(678+726x2)	308+330x2(678+726x2)	330x3(726x3)
	220V	kg(lbs.)	305+330x2(671+726x2)	308+330x2(678+726x2)	330x3(726x3)
Operating temperature range	°C(°F) Cooling: -5-48(23~118.4); Heating: -20-24(-4~75.2)				



HP	380~415V		56	58	60
Model MDV-	1560(56)W/D2CN1(B)		1630(58)W/D2CN1(B)	1680(60)W/D2CN1(B)	
Model MDV-	1560(56)W/D2DN1(B)		1630(58)W/D2DN1(B)	1680(60)W/D2DN1(B)	
Combined type	10HPx2+18HPx2		10HP+14HP+16HP+18HP	10HP+14HP+18HPx2	
Power supply	V/Ph/Hz		380-415/3/60 & 220/3/60		
Cooling	Capacity	kW	156.0	163.0	168.0
		kBtu/h	532.3	556.2	573.2
	Power input	kW	43.69	46.38	47.94
	EER		3.57	3.51	3.50
Heating	Capacity	kW	175.0	182.5	188.5
		kBtu/h	597.1	622.7	643.2
	Power input	kW	43.90	45.93	47.54
	COP		3.99	3.97	3.97
Connectable indoor unit	50~130% of outdoor unit capacity				
Compressor	Total capacity		64		
	Max. quantity		6		
	Type		DC inverter		
Fan motor	Quantity		6		
	Type		DC motor		
	Quantity		6		
Refrigerant	Type		R410A		
	Factory charging (380~415V)	kg(lbs.)	10x2+16x2(22x2+35x2)	10+15x2+16(22+33x2+35)	10+15+16x2(22+33+35x2)
	Factory charging (220V)	kg(lbs.)	9x2+16x2(20x2+35x2)	9+13x2+16(20+29x2+35)	9+13+16x2(20+29+35x2)
Pipe connections	Liquid pipe	mm(in.)	Φ22.2(Φ7/8)		
	Gas pipe	mm(in.)	Φ41.3(Φ1-5/8)		
	Oil balance pipe	mm(in.)	Φ6(Φ1/4)		
	Air flow rate	m ³ /h	11242x2+15620x2	11242+15620x3	11242+15620x3
Sound pressure level	dB(A)	66			
Net dimension (WxHxD)	mm	(960x1615x765)x2+(1250x1615x765)x2	(960x1615x765)+(1250x1615x765)x3		
Packing size (WxHxD)	mm	(1025x1790x820)x2+(1305x1790x820)x2	(1025x1790x830)+(1305x1790x820)x3		
Net weight	380~415V	kg(lbs.)	212x2+310x2(466x2+682x2)	212+288x2+310(466+634x2+682)	212+288+310x2(466+634+682x2)
	220V	kg(lbs.)	202x2+310x2(444x2+682x2)	202+285+288+310(444+627+634+682)	202+285+310x2(444+627+682x2)
Gross weight	380~415V	kg(lbs.)	227x2+330x2(499x2+726x2)	227+308x2+330(499+678x2+726)	227+308+330x2(499+678+726x2)
	220V	kg(lbs.)	218x2+330x2(480x2+726x2)	218+305+308+330(480+671+678+726)	218+305+330x2(480+671+726x2)
Operating temperature range	°C(°F) Cooling: -5-48(23~118.4); Heating: -20-24(-4~75.2)				

Notes:

Capacities are based on the following conditions:

Cooling: Indoor temperature 27°C(80.6°F) DB/19°C(66.2°F) WB; Outdoor temperature 35°C(95°F) DB/24°C(75.2°F) WB.

Heating: Indoor temperature 20°C(68°F) DB/15°C(59°F) WB; Outdoor temperature 7°C(44.6°F) DB/6°C(42.8°F) WB.

Piping length: Interconnecting piping length is 7.5m(24.6ft.), level difference is zero.

Connection piping diameter of single-unit is the stop valve diameter of the unit.

Connection piping diameter of multi-unit is the main pipe connecting to the first indoor branch joint, in case of the total equivalent liquid length is less than 90m(295ft.). If the total equivalent liquid length is more than 90m(295ft.), please refer to technical manual to choose the connection piping diameter.

Sound values are measured in a semi-anechoic room, at a position of 1m(3.28ft) in front of the unit and 1.3m(4.26ft) above the floor.

VRF V4 Plus S Series - Heat Pump

380~415V-60Hz / 220V-60Hz



HP	380~415V		62	64	66
Model MDV-	1730(62)W/D2CN1(B)		1780(64)W/D2CN1(B)	1850(66)W/D2CN1(B)	
Model MDV-	1730(62)W/D2DN1(B)		1780(64)W/D2DN1(B)	1850(66)W/D2DN1(B)	
Combined type	10HP+18HPx3		10HP+16HP+18HPx2	14HP+16HP+18HPx2	
Power supply	V/Ph/Hz		380-415/3/60 & 220/3/60		
Cooling	Capacity	kW	173.0	178.0	185.0
		kBtu/h	590.3	607.3	631.2
	Power input	kW	49.87	51.43	54.12
	EER		3.47	3.46	3.42
Heating	Capacity	kW	193.5	199.5	207.0
		kBtu/h	660.2	680.7	706.3
	Power input	kW	49.13	50.74	52.77
	COP		3.94	3.93	3.92
Connectable indoor unit	50~130% of outdoor unit capacity				
Compressor	Total capacity		64		
	Max. quantity		7		
	Type		DC inverter		
Fan motor	Quantity		7		
	Type		DC motor		
	Quantity		7		
Refrigerant	Type		R410A		
	Factory charging (380~415V)	kg(lbs.)	10+15+16x2(22+33+35x2)	10+16x3(22+35x3)	15x2+16x2(33x2+35x2)
	Factory charging (220V)	kg(lbs.)	9+13+16x2(20+29+35x2)	9+16x3(20+35x3)	13x2+16x2(29x2+35x2)
Pipe connections	Liquid pipe	mm(in.)	Φ22.2(Φ7/8)		
	Gas pipe	mm(in.)	Φ41.3(Φ1-5/8)		
	Oil balance pipe	mm(in.)	Φ6(Φ1/4)		
	Air flow rate	m ³ /h	11242+15620x3		
Sound pressure level	dB(A)	67			
Net dimension (WxHxD)	mm	(960x1615x765)+(1250x1615x765)x3			
Packing size (WxHxD)	mm	(1025x1790x830)+(1305x1790x820)x3			
Net weight	380~415V	kg(lbs.)	212+288+310x2(466+634+682x2)	212+310x3(466+682x3)	288x2+310x2(634x2+682x2)
	220V	kg(lbs.)	202+288+310x2(444+634+682x2)	202+310x3(444+682x3)	285+288+310x2(627+634+682x2)
Gross weight	380~415V	kg(lbs.)	227+308+330x2(499+678+726x2)	227+330x3(499+726x3)	308x2+330x2(678x2+726x2)
	220V	kg(lbs.)	218+308+330x2(480+678+726x2)	218+330x3(480+726x3)	305+308+330x2(671+678+726x2)
Operating temperature range	°C(°F) Cooling: -5-48(23~118.4); Heating: -20-24(-4~75.2)				

Notes:

Capacities are based on the following conditions:

Cooling: Indoor temperature 27°C(80.6°F) DB/19°C(66.2°F) WB; Outdoor temperature 35°C(95°F) DB/24°C(75.2°F) WB.

Heating: Indoor temperature 20°C(68°F) DB/15°C(59°F) WB; Outdoor temperature 7°C(44.6°F) DB/6°C(42.8°F) WB.

Piping length: Interconnecting piping length is 7.5m(24.6ft.), level difference is zero.

Connection piping diameter of single-unit is the stop valve diameter of the unit.

Connection piping diameter of multi-unit is the main pipe connecting to the first indoor branch joint, in case of the total equivalent liquid length is less than 90m(295ft.). If the total equivalent liquid length is more than 90m(295ft.), please refer to technical manual to choose the connection piping diameter.

Sound values are measured in a semi-anechoic room, at a position of 1m(3.28ft) in front of the unit and 1.3m(4.26ft) above the floor.



» INDOOR UNITS

One-way Cassette
Two-way Cassette
Compact Four-way Cassette
Four-way Cassette
Low Static Pressure Duct
Medium Static Pressure Duct (A5 type)

High Static Pressure Duct
Wall-mounted
Ceiling & Floor
Fresh Air Processing Unit

Cassette Series



One-way Cassette



Two-way Cassette



Compact Four-way Cassette



Four-way Cassette



One-way Cassette

Thickness 153mm (6-1/32in.) only >>

Compact design, ultra slim body with a minimum thickness of 153mm(6-1/32in.) for models 18-36, especially suitable for narrow ceiling, such as in lobbies and small meeting rooms.

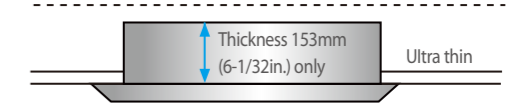

High-lift Pump >>

Standard built-in drain pump with 750mm(29-17/32in.) pump head.

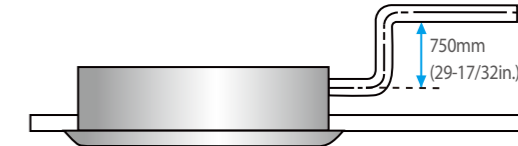

Fresh Air, Improved Air Quality >>

Reserved fresh air intake port for high quality air creates a comfortable and healthy environment (for models 45-71).



Specifications

Model		MDV-D18Q1/AN1-D	MDV-D22Q1/AN1-D	MDV-D28Q1/AN1-D	MDV-D36Q1/AN1-D	MDV-D45Q1/AN1-D	MDV-D56Q1/AN1-D	MDV-D71Q1/AN1-D	
Power supply		1-phase,208-230V,60Hz							
Cooling capacity	kW	1.8	2.2	2.8	3.6	4.5	5.6	7.1	
	Btu/h	6100	7500	9600	12300	15400	19100	24200	
Heating capacity	kW	2.2	2.6	3.2	4.0	5.0	6.3	8.0	
	Btu/h	7500	8900	10900	13600	17100	21500	27300	
Power input	Cooling	W	41	41	41	41	54	60	75
	Heating	W	41	41	41	41	44	50	65
Airflow rate(H/M/L)	m ³ /h	523/404/275	523/404/275	573/456/315	573/456/315	693/600/476	792/688/549	933/749/592	
	CFM	308/238/162	308/238/162	337/268/185	337/268/185	408/353/280	466/405/323	549/441/349	
Sound pressure level(H/M/L)	dB(A)	37/34/30	38/34/30	39/37/34	40/38/34	41/39/35	42/40/36	44/41/37	
Main body	Net dim.(WxHxD)	mm(in.) 1054x153x425(41-1/2x6-1/32x16-47/64)						1275x189x450(50-13/64x7-7/16x17-23/32)	
	Packing dim.(WxHxD)	mm(in.) 1155x245x490(45-15/32x9-41/64x19-19/64)						1370x295x505(53-15/16x11-39/64x19-7/8)	
	Net/gross weight	kg(lbs.) 12.5/16(27.8/35.3)						18.5/22.8(40.8/50.3) 18.8/23.1(41.4/50.9) 19.5/23.8(43.0/52.5)	
Panel	Net dim.(WxHxD)	mm(in.) 1180x25x465(46-29/64x63/64x18-5/16)						1350x25x505(53-5/32x63/64x19-7/8)	
	Packing dim.(WxHxD)	mm(in.) 1232x107x517(48-1/2x4-7/32x20-23/64)						1410x95x560(55-33/64x3-47/64x22-3/64)	
	Net/gross weight	kg(lbs.) 3.5/5.2(7.7/11.5)						4/5.4(8.8/11.9)	
Piping connections	Liquid/gas pipe	mm(in.) Φ6.35/Φ12.7(Φ1/4/Φ1/2)						Φ9.53/Φ15.9(Φ3/8/Φ5/8)	
	Drain pipe	mm(in.) Φ25(OD 63/64)							
Standard controller		Wireless remote controller RM05/BG(T)E-A							

- Notes:
- Nominal cooling capacities are based on the following conditions: return air temp.: 27°C(80.6°F)DB, 19°C(66.2°F)WB, outdoor temp.: 35°C(95°F)DB, equivalent ref. piping: 8m(26.25ft) (horizontal).
 - Nominal heating capacities are based on the following conditions: return air temp.: 20°C(68°F)DB, outdoor temp.: 7°C (44.6°F)DB, 6°C(42.8°F)WB, equivalent ref. piping: 8m(26.25ft) (horizontal).
 - Sound Level is measured 1.4m(4.59ft.) below the unit.



Two-way Cassette

Quiet Operation >>

Optimized airflow duct with low resistance greatly reduces noise, down to a minimum of 24dB(A).

Stylish Design and Slim Body >>

Thanks to the stylish appearance and slim body, the unit can be harmonious with the room decoration and ambient. Slim body with only 300mm(11-13/16in.) height needs small space in suspended ceilings. Installation is free of story height limitation which makes the decoration much more flexible.

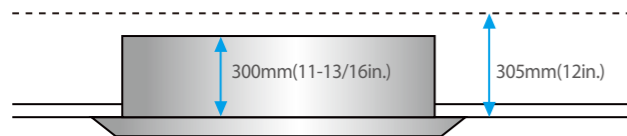

High-lift Pump >>

Standard built-in drain pump with 750mm(29-17/32in.) pump head (higher pumphead can be customized).

High Airflow >>

High airflow for high ceiling application guarantees comfort in large spaces. Guarantees even airflow and temperature throughout the room.



Specifications

Model	MDV-D22Q2/VN1	MDV-D28Q2/VN1	MDV-D36Q2/VN1	MDV-D45Q2/VN1	MDV-D56Q2/VN1	MDV-D71Q2/VN1		
Power supply	1-phase, 208-230V, 60Hz							
Cooling capacity	kW	2.2	2.8	3.6	4.5	5.6	7.1	
	Btu/h	7500	9600	12300	15400	19100	24200	
Heating capacity	kW	2.6	3.2	4.0	5.0	6.3	8.0	
	Btu/h	8900	10900	13600	17100	21500	27300	
Power input	Cooling	W	78	78	83	115	133	205
	Heating	W	78	78	83	115	133	205
Airflow rate(H/M/L)	m ³ /h	674/509/381	674/509/381	740/577/435	878/689/561	941/776/654	1236/1110/864	
	CFM	397/300/224	397/300/224	436/340/256	517/406/330	554/457/385	727/653/509	
Sound pressure level(H/M/L)	dB(A)	33/29/24	36/32/29	36/32/29	39/35/30	39/35/30	44/40/34	
Main body	Net dim.(WxHxD)	1172x299x591(46-9/32x11-49/64x23-17/64)						
	Packing dim.(WxHxD)	1355x400x675(53-11/32x15-3/4x26-37/64)						
	Net/gross weight	34/42.5(75/94)						
Panel	Net dim.(WxHxD)	1430x53x680(56-19/64x2-3/32x26-49/64)						
	Packing dim.(WxHxD)	1525x130x765(60-3/64x5-1/8x30-1/8)						
	Net/gross weight	10.5/15(23/33)						
Piping connections	Liquid/gas pipe	Φ6.35/Φ12.7(Φ1/4/Φ1/2)				Φ9.53/Φ15.9(Φ3/8/Φ5/8)		
	Drain pipe	Φ32(OD 1-17/64)						
Standard controller	Wireless remote controller RM05/BG(T)E-A							

- Notes:
- Nominal cooling capacities are based on the following conditions: return air temp.: 27°C(80.6°F)DB, 19°C(66.2°F)WB, outdoor temp.: 35°C(95°F)DB, equivalent ref. piping: 8m(26.25ft.) (horizontal).
 - Nominal heating capacities are based on the following conditions: return air temp.: 20°C(68°F)DB, outdoor temp.: 7°C(44.6°F)DB, 6°C(42.8°F)WB, equivalent ref. piping: 8m(26.25ft.) (horizontal).
 - Sound Level is measured 1.4m(4.59ft.) below the unit.

Four-way Cassette

Various Selections >>

Three selections: Compact Four-way Cassette, Four-way Cassette & Four-way Cassette Silent Type.

Flexible Air Distribution Type >>

7 discharge patterns in 2 to 4 directions can be selected to suit the requirements of the installation site or the shape of the room.

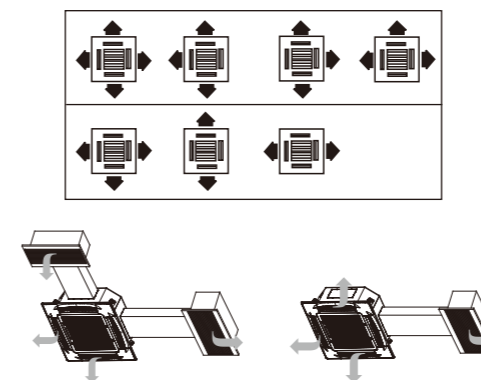

Duct connection is possible

Compact Design, Easy Installation >>

For Compact Four-way Cassette: Extremely compact casing suits any room's decor and requires little space for installation on a low ceiling. Due to compact body and light weight, all models can be installed without a hoist.

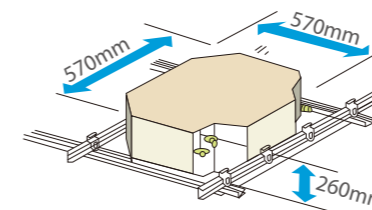

360° Airflow Outlet >>

For Compact Four-way Cassette: 360° air outlet provides strong air flow circulation to cool or heat every corner of a room and evenly control temperatures.



Sub Duct >>

Sub duct enables you to use the same air conditioner unit to cool an additional smaller space nearby.

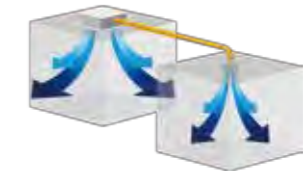

Fresh Air Intake >>

Fresh air can enter through the cassette unit so you can enjoy even fresher air in a room.



Easy Troubleshooting >>

For Four-way Cassette & Four-way Cassette Silent Type: By adding digital tube on the display board, Error Codes can be displayed directly for troubleshooting.



Lower Operating Noise >>

For Four-way Cassette Silent Type: The newly designed fan blade, air deflector and the built-in throttling part reduce noise greatly.



High-lift Drain Pump >>

For Compact Four-way Cassette: Drain pump with a 500mm(19-11/16in.) pump head is fitted as standard; maximum 600mm(23-5/8in.) pump head is available. For Four-way Cassette & Four-way Cassette Silent Type: Drain pump can pump condenser water up to 750mm(29-17/32in.) high, which simplifies installation of the drain piping system.

Compact Four-way Cassette

Model		MDV-D22Q4/VN1-A3	MDV-D28Q4/VN1-A3	MDV-D36Q4/VN1-A3	MDV-D45Q4/VN1-A3
Power supply		1-phase, 208-230V, 60Hz			
Cooling capacity	kW	2.2	2.8	3.6	4.5
	Btu/h	7500	9600	12300	15400
Heating capacity	kW	2.4	3.2	4.0	5.0
	Btu/h	8200	10900	13600	17100
Power input	Cooling	W	51	52	58
	Heating	W	43	44	50
Airflow rate(H/M/L)	m ³ /h	397/292/215	408/310/231	496/359/263	496/359/263
	CFM	234/172/127	240/182/136	292/211/155	292/211/155
Sound pressure level(H/M/L)	dB(A)	35.8/33.4/23.4	35.8/33.4/23.4	41.5/35.6/28.8	41.5/35.6/28.8
Main body	Net dim.(WxHxD)	mm(in.) 570x260x570(22-7/16x10-15/64x22-7/16)			
	Packing dim.(WxHxD)	mm(in.) 675x285x675(26-9/16x11-7/32x26-9/16)			
	Net/gross weight	kg(lbs.) 16/20(35.3/44.1)		18/22(39.7/48.5)	
Panel	Net dim.(WxHxD)	mm(in.) 647x50x647(25-15/32x1-31/32x25-15/2)			
	Packing dim.(WxHxD)	mm(in.) 715x123x715(28-5/32x4-27/32x28-5/32)			
	Net/gross weight	kg(lbs.) 3/5(6.6/11)			
Piping connections	Liquid/gas pipe	mm(in.) Φ 6.35/ Φ 12.7(Φ 1/4/ Φ 1/2)			
	Drain pipe	mm(in.) Φ 25(OD 63/64)			
Standard controller		Wireless remote controller RM05/BG(T)E-A			

Four-way Cassette

Model		MDV-D28Q4/N1-D	MDV-D36Q4/N1-D	MDV-D45Q4/N1-D	MDV-D56Q4/N1-D	MDV-D71Q4/N1-D
Power supply		1-phase, 220-240V, 60Hz				
Cooling capacity	kW	2.8	3.6	4.5	5.6	7.1
	Btu/h	9600	12300	15400	19100	24200
Heating capacity	kW	3.2	4.0	5.0	6.3	8.0
	Btu/h	10900	13600	17100	21500	27300
Power input	Cooling	W	90	90	90	115
	Heating	W	90	90	90	115
Airflow rate(H/M/L)	m ³ /h	847/766/640	847/766/640	864/755/658	864/755/658	1157/955/749
	CFM	499/451/377	499/451/377	509/444/387	509/444/387	681/562/441
Sound pressure level(H/M/L)	dB(A)	42/38/35	42/38/35	42/38/35	42/38/35	45/42/39
Main body	Net dim.(WxHxD)	mm(in.) 904x230x840(35-19/32x9-1/16x33-5/64)				
	Packing dim.(WxHxD)	mm(in.) 955x260x955(37-19/32x10-15/64x37-19/32)				
	Net/gross weight	kg(lbs.) 24/28(53/61.7)		26/30(57.3/66.2)		
Panel	Net dim.(WxHxD)	mm(in.) 950x54.5x950(37-13/32x2-9/64x37-13/32)				
	Packing dim.(WxHxD)	mm(in.) 1035x90x1035(40-3/4x3-35/64x40-3/4)				
	Net/gross weight	kg(lbs.) 5/8(11.0/17.6)				
Piping connections	Liquid/gas pipe	mm(in.) Φ 6.35/ Φ 12.7(Φ 1/4/ Φ 1/2)		Φ 9.53/ Φ 15.9(Φ 3/8/ Φ 5/8)		
	Drain pipe	mm(in.) Φ 32(OD 1-17/64)				
Standard controller		Wireless remote controller RM05/BG(T)E-A				

Model		MDV-D80Q4/N1-D	MDV-D90Q4/N1-D	MDV-D100Q4/N1-D	MDV-D112Q4/N1-D	MDV-D140Q4/N1-D
Power supply		1-phase, 220-240V, 60Hz				
Cooling capacity	kW	8.0	9.0	10.0	11.2	14.0
	Btu/h	27300	30700	34100	38200	47800
Heating capacity	kW	9.0	10.0	11.1	12.5	15.0
	Btu/h	30700	34100	37900	42700	51200
Power input	Cooling	W	115	160	160	180
	Heating	W	115	160	160	160
Airflow rate(H/M/L)	m ³ /h	1236/973/729	1590/1300/1090	1590/1300/1090	1590/1300/1090	1678/1358/1115
	CFM	727/573/429	936/765/642	936/765/642	936/765/642	988/799/656
Sound pressure level(H/M/L)	dB(A)	45/42/39	48/45/43	48/45/43	48/45/43	50/47/44
Main body	Net dim.(WxHxD)	mm(in.) 904x230x840(35-19/32x9-1/16x33-5/64)				
	Packing dim.(WxHxD)	mm(in.) 955x260x955(37-19/32x10-15/64x37-19/32)				
	Net/gross weight	kg(lbs.) 26/30(57.3/66)		32/37(70.5/81.6)		
Panel	Net dim.(WxHxD)	mm(in.) 950x54.5x950(37-13/32x2-9/64x37-13/32)				
	Packing dim.(WxHxD)	mm(in.) 1035x90x1035(40-3/4x3-35/64x40-3/4)				
	Net/gross weight	kg(lbs.) 5/8(11.0/17.6)				
Piping connections	Liquid/gas pipe	mm(in.) Φ 9.53/ Φ 15.9(Φ 3/8/ Φ 5/8)				
	Drain pipe	mm(in.) Φ 32(OD 1-17/64)				
Standard controller		Wireless remote controller RM05/BG(T)E-A				

Four-way Cassette Silent Type

Model		MDV-D28Q4/VN1-E	MDV-D36Q4/VN1-E	MDV-D45Q4/VN1-E	MDV-D56Q4/VN1-E	MDV-D71Q4/VN1-E
Power supply		1-phase, 208-230V, 60Hz				
Cooling capacity	kW	2.8	3.6	4.5	5.6	7.1
	Btu/h	9600	12300	15400	19100	24200
Heating capacity	kW	3.2	4.0	5.0	6.3	8.0
	Btu/h	10900	13600	17100	21500	27300
Power input	Cooling	W	80	80	88	105
	Heating	W	80	80	88	88
Airflow rate(H/M/L)	m ³ /h	791/674/596	791/674/596	942/777/662	942/777/662	1235/1013/805
	CFM	465/396/351	465/396/351	554/457/389	554/457/389	726/596/474
Sound pressure level(H/M/L)	dB(A)	30/25/22	30/25/22	35/31/27	35/31/27	43/37/31
Main body	Net dim.(WxHxD)	mm(in.) 840x230x840(33-1/16x9-1/16x33-1/16)				
	Packing dim.(WxHxD)	mm(in.) 955x260x955(37-19/32x10-1/4x37-19/32)				
	Net/gross weight	kg(lbs.) 21.5/26.7(47.3/58.7)		23.7/28.9(52.1/63.6)		
Panel	Net dim.(WxHxD)	mm(in.) 950x54.5x950(37-13/32x2-9/64x37-13/32)				
	Packing dim.(WxHxD)	mm(in.) 1035x90x1035(40-3/4x3-9/16x40-3/4)				
	Net/gross weight	kg(lbs.) 6/9(13.2/19.8)				
Piping connections	Liquid/gas pipe	mm(in.) Φ 6.35/ Φ 12.7(Φ 1/4/ Φ 1/2)			Φ 9.53/ Φ 15.9(Φ 3/8/ Φ 5/8)	
	Drain pipe	mm(in.) Φ 32(OD 1-17/64)				
Standard controller		Wireless remote controller RM05/BG(T)E-A				

Model		MDV-D80Q4/VN1-E	MDV-D90Q4/VN1-E	MDV-D100Q4/VN1-E	MDV-D112Q4/VN1-E	MDV-D140Q4/VN1-E
Power supply		1-phase, 208-230V, 60Hz				
Cooling capacity	kW	8.0	9.0	10.0	11.2	14.0
	Btu/h	27300	30700	34100	38200	47800
Heating capacity	kW	9.0	10.0	11.1	12.5	15.0
	Btu/h	30700	34100	37900	42700	51200
Power input	Cooling	W	120	187	200	220
	Heating	W	120	187	200	200
Airflow rate(H/M/L)	m ³ /h	1235/1013/805	1333/1158/957	1634/1219/1139	1634/1219/1139	1634/1219/1139
	CFM	726/596/474	784/681/563	961/717/670	961/717/670	995/731/681
Sound pressure level(H/M/L)	dB(A)	43/37/31	43/38/32	45/37/35	45/37/35	46/38/37
Main body	Net dim.(WxHxD)	mm(in.) 840x230x840(33-1/16x9-1/16x33-1/16)		840x300x840(33-1/16x11-13/16x33-1/16)		
	Packing dim.(WxHxD)	mm(in.) 955x260x955(37-19/32x10-15/64x37-19/32)		955x330x955(37-19/32x11-13/16x37-19/32)		
	Net/gross weight	kg(lbs.) 23.7/28.9(52.1/63.6)		28.7/34.1(63.1/75)		30.9/36.3(68/79.9)
Panel	Net dim.(WxHxD)	mm(in.) 950x54.5x950(37-13/32x2-9/64x37-13/32)				
	Packing dim.(WxHxD)	mm(in.) 1035x90x1035(40-3/4x3-35/64x40-3/4)				
	Net/gross weight	kg(lbs.) 6/9(13.2/19.8)				
Piping connections	Liquid/gas pipe	mm(in.) Φ 9.53/ Φ 15.9(Φ 3/8/ Φ 5/8)				
	Drain pipe	mm(in.) Φ 32(OD 1-17/64)				
Standard controller		Wireless remote controller RM05/BG(T)E-A				

Notes:

- Nominal cooling capacities are based on the following conditions: return air temp.: 27°C(80.6°F)DB, 19°C(66.2°F)WB, outdoor temp.: 35°C(95°F)DB, equivalent ref. piping: 8m(26.25ft) (horizontal).
- Nominal heating capacities are based on the following conditions: return air temp.: 20°C(68°F)DB, outdoor temp.: 7°C(44.6°F)DB, 6°C(42.8°F)WB, equivalent ref. piping: 8m(26.25ft) (horizontal).
- Sound Level is measured 1.4m(4.59ft) below the unit.

Duct series



Low static pressure duct

Medium pressure duct (A5 type)

High Static Pressure Duct

Fresh Air Processing Unit

Low Static Pressure Duct

Low Sound Level >>

Utilizes the centrifugal type blower, provides a minimum noise level of 24dB (A), an excellent choice for hotels and other sound-sensitive locations.



V Shape Evaporator >>

V shape evaporator design enhances heat exchanging efficiency by around 22%.

Easy Installation and Maintenance >>

The EXV is fixed inside the indoor unit.

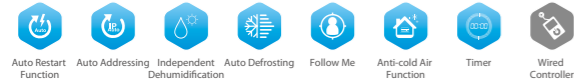

Specifications

Model	MDV-D18T3/VN1-C	MDV-D22T3/VN1-C	MDV-D28T3/VN1-C	MDV-D36T3/VN1-C	MDV-D45T3/VN1-C	MDV-D56T3/VN1-C	MDV-D71T3/VN1-C
Power supply	1-phase,208-230V,60Hz						
Cooling capacity	kW	1.8	2.2	2.8	3.6	4.5	7.1
	Btu/h	6100	7500	9600	12300	15400	24200
Heating capacity	kW	2.2	2.6	3.2	4.0	5.0	8.0
	Btu/h	7500	8900	10900	13600	17100	27300
Power input	Cooling	W	59	59	59	65	105
	Heating	W	59	59	59	65	105
Airflow rate(H/M/L)	m³/h	578/512/409	578/512/409	578/512/409	617/551/441	824/690/609	824/690/609
	CFM	340/301/241	340/301/241	340/301/241	363/324/260	485/406/358	485/406/358
External static pressure(Min/Std/Max)	Pa	0/10/30	0/10/30	0/10/30	0/10/30	0/10/30	0/10/30
Sound pressure level(H/M/L)	dB(A)	35/27/24	35/27/24	35/27/24	38/32/28	39/32/29	39/32/29
Net dimension(WxHxD)	mm(in.)	740x210x470(29-9/64x8-17/64x18-1/2)			960x210x470(37-51/64x8-17/64x18-1/2)		1180x210x470(46-29/64x8-17/64x18-1/2)
Packing dimension(WxHxD)	mm(in.)	910x230x510(35-53/64x9-1/16x20-5/64)			1130x230x510(44-31/64x9-1/16x20-5/64)		1350x230x510(53-5/32x9-1/16x20-5/64)
Net/gross weight	kg(lbs.)	14.5/18(32.0/39.7)			18/22.5(39.7/49.6)		22.5/26.5(49.6/58.5)
Piping connections	Liquid/gas pipe	mm(in.)			mm(in.)		mm(in.)
	Drain piping	mm(in.)			mm(in.)		mm(in.)
Standard controller	Wireless remote controller RM05/BG(T)E-A						

Notes:

- Nominal cooling capacities are based on the following conditions: return air temp.: 27°C(80.6°F)DB, 19°C(66.2°F)WB, outdoor temp.: 35°C(95°F)DB, equivalent ref. piping: 8m(26.25ft.) (horizontal).
 - Nominal heating capacities are based on the following conditions: return air temp.: 20°C(68°F)DB, outdoor temp.: 7°C (44.6°F)DB, 6°C(42.8°F)WB, equivalent ref. piping: 8m(26.25ft.) (horizontal).
 - Sound Level is measured 1.4m(4.59ft.) below the unit.
- * External static pressure is based on high speed indoor air flow.

Medium Static Pressure Duct (A5 type)

Compact Size >>

Only 210mm(8-9/32in.) (models 22~71) or 270mm(10-5/8in.) (models 80 to 112) or 300mm(11-13/16in.) (model 140) in height.

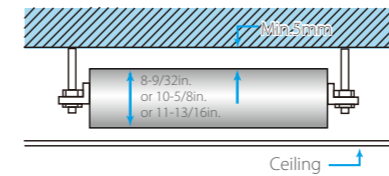

Flexible Control and Easy Maintenance >>

The electrical control box can be removed 1m away from the unit for easy maintenance access. Customers need to request this service in advance for it is done at TGM CAC factory. Standard functional ports are included such as Remote On/Off Dry contact switch and Alarm signal output (220V).

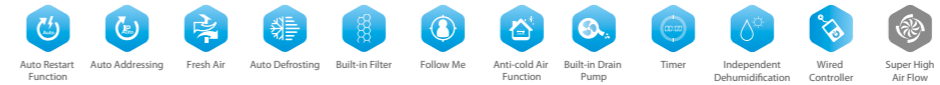

Specifications

Model	MDV-D22T2/VN1-DA5	MDV-D28T2/VN1-DA5	MDV-D36T2/VN1-DA5	MDV-D45T2/VN1-DA5	MDV-D56T2/VN1-DA5
Power supply	1-phase,208-230V,60Hz				
Cooling capacity	kW	2.2	2.8	3.6	4.5
	Btu/h	7500	9600	12300	15400
Heating capacity	kW	2.6	3.2	4.0	5.0
	Btu/h	8200	10900	13600	17100
Power input	Cooling	W	66	72	77
	Heating	W	66	72	77
Airflow rate(H/M/L)	m³/h	538/456/375	538/456/375	597/514/429	811/684/575
External static pressure(Min/Std/Max)	Pa	0/10/30	0/10/30	0/10/30	0/10/30
Sound pressure level(H/M/L)	dB(A)	36/35/32	36/35/32	38.6/37.5/33.8	39/37.9/34
Net dimension(WxHxD)	mm(in.)	740x210x500(29-9/64x8-17/64x19-11/16)			960x210x500(37-51/64x8-17/64x19-11/16)
Packing dimension(WxHxD)	mm(in.)	870x285x525(34-1/4x11-7/32x20-43/64)			1115x285x525(43-57/64x11-7/32x20-43/64)
Net/gross weight	kg(lbs.)	17.5/20(38.6/44.1)			22.5/26(49.6/57.3)
Piping connections	Liquid/gas pipe	mm(in.)			mm(in.)
	Drain piping	mm(in.)			mm(in.)
Standard controller	Wired controller KJR-29B1/BK-E (6 meters connection wire)				

Model	MDV-D71T2/VN1-DA5	MDV-D80T2/VN1-BA5	MDV-D90T2/VN1-BA5	MDV-D112T2/VN1-BA5	MDV-D140T2/VN1-BA5
Power supply	1-phase,208-230V,60Hz				
Cooling capacity	kW	7.1	8.0	9.0	11.2
	Btu/h	24200	27300	30700	38200
Heating capacity	kW	8.0	9.0	10.0	12.5
	Btu/h	27300	30700	34100	42700
Power input	Cooling	W	125	133	134
	Heating	W	125	133	134
Airflow rate(H/M/L)	m³/h	1029/934/781	1345/1165/1013	1345/1165/1013	1800/1556/1400
External static pressure(Min/Std/Max)	Pa	0/10/30	0/10/30	0/10/30	0/10/80
Sound pressure level(H/M/L)	dB(A)	41.4/39/35	45.4/39.8/37	45.4/39.8/37	48.0/41.9/38
Net dimension(WxHxD)	mm(in.)	1180x210x500(46-29/64x8-17/64x19-11/16)		1230x270x775(48-27/64x10-5/8x30-33/64)	
Packing dimension(WxHxD)	mm(in.)	1335x285x525(52-9/16x11-7/32x20-43/64)		1355x350x795(53-11/32x13-25/31x31-19/64)	
Net/gross weight	kg(lbs.)	28/31.5(61.8/69.5)		38/46.5(84/102.5)	
Piping connections	Liquid/gas pipe	mm(in.)			mm(in.)
	Drain piping	mm(in.)			mm(in.)
Standard controller	Wired controller KJR-29B1/BK-E (6 meters connection wire)				

Notes:

- Nominal cooling capacities are based on the following conditions: return air temp.: 27°C(80.6°F)DB, 19°C(66.2°F)WB, outdoor temp.: 35°C(95°F)DB, equivalent ref. piping: 8m(26.25ft.) (horizontal).
 - Nominal heating capacities are based on the following conditions: return air temp.: 20°C(68°F)DB, outdoor temp.: 7°C (44.6°F)DB, 6°C(42.8°F)WB, equivalent ref. piping: 8m(26.25ft.) (horizontal).
 - Sound Level is measured 1.4m(4.59ft.) below the unit.
- * External static pressure is based on high speed indoor air flow.

High Static Pressure Duct

Flexible Duct Design >>

External static pressure can be up to 196Pa (models 71 to 160) or 280Pa (models 200 to 560).
 The maximum length for air supply is about 14m(45.9ft) at a height of 6.5m(21.3ft).
 With a 420mm(16-17/32in.) (models 71 to 160) thick body, the minimum distance required above the ceiling is 450mm (17-23/32in.).

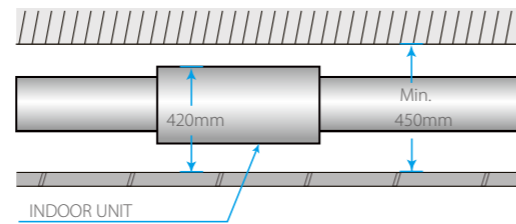
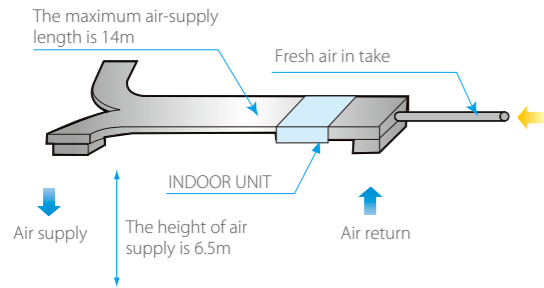

Double-skin Drainage Pan >>

Double-skin drainage pan provides double protection for ceilings (models 71 to 160 and models 400 to 560).

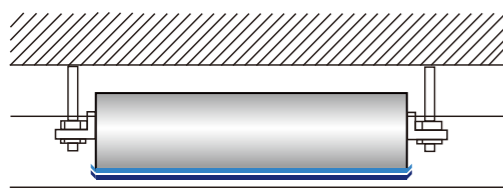

Option >>

Drain pump with 750mm(29-17/32in.) pump head is optional (models 71 to 160).

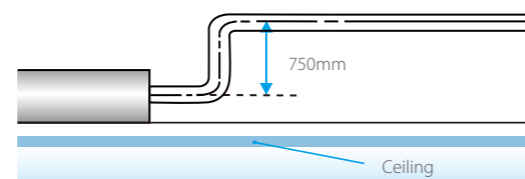

Convenient Installation >>

The EXV is fixed inside the indoor unit (models 70-160), requires no extra connection.
 Standard filter is housed in an aluminum frame, which is removable from the bottom in a downward direction.
 Flange for air inlet/outlet duct connection is standard.

Flexible Control and Convenient for Maintenance >>

Wired remote controller KJR-29B1/BK-E comes standard, and wireless remote controller RM05/BG(T)E-A comes as an option.
 The display board is connected to the E-box in factory, easier troubleshooting with LED display.
 Easy access filters both at the rear & bottom.
 Standard functional port such as remote on/off dry contact.



Specification

Model		MDV-D71T1/VN1-B	MDV-D80T1/VN1-B	MDV-D90T1/VN1-B	MDV-D112T1/VN1-B	MDV-D140T1/VN1-B	MDV-D160T1/VN1-B
Power supply		1-phase,208-230V,60Hz					
Cooling capacity	kW	7.1	8	9	11.2	14	16
	Btu/h	24200	27300	30700	38200	47800	54600
Heating capacity	kW	8	9	10	12.5	16	16.5
	Btu/h	27300	30700	34100	42700	54600	56300
Power input	Cooling	W	414	402	409	409	527
	Heating	W	414	402	409	409	527
Airflow rate(H/M/L)	m ³ /h	1683/1550/1317	1683/1550/1317	2240/2020/1590	2186/1975/1560	2969/2694/2469	2969/2694/2469
	CFM	990/912/775	990/912/775	1318/1188/935	1286/1162/918	1746/1586/1453	1746/1586/1453
External static pressure(Min/Std/Max)	Pa	30/40/196	30/40/196	30/40/196	30/50/196	30/50/196	30/50/196
Sound pressure level(H/M/L)	dB(A)	48/46/44.5	48/46/44.5	52/49/47	52/49/47	53/50/48	54/52/50
Net dimension(WxHxD)	mm(in.)	952x420x690(37-31/64x16-17/32x27-11/64)				1300x420x691(51-3/16x15-3/4x27-13/64)	
Packing dimension(WxHxD)	mm(in.)	1090x440x768(42-29/32x17-21/64x30-15/64)				1436x450x768(56-17/32x17-23/32x30-15/64)	
Net/gross weight	kg(lbs.)	46.5/52(102.6/114.7)		50/56.5(110.3/124.6)		68/70(149.9/154.3)	
Piping connections	Liquid/gas pipe	mm(in.) Φ9.53/Φ15.9(Φ3/8/Φ5/8)					
	Drain piping	mm(in.) Φ25(OD 63/64)					
Standard controller		Wired controller KJR-29B1/BK-E (6 meters connection wire)					

Model		MDV-D200T1/N1-B	MDV-D250T1/N1-B	MDV-D280T1/N1-B	MDV-D400T1/N1	MDV-D450T1/N1
Power supply		1-phase,208-230V,60Hz				
Cooling capacity	kW	20.0	25.0	28.0	40.0	45.0
	Btu/h	68200	85300	95500	136500	153500
Heating capacity	kW	22.5	26.0	31.5	45.0	50.0
	Btu/h	76800	88700	107500	153500	170600
Power input	Cooling	W	1516	1516	1516	1600
	Heating	W	1516	1516	1516	1600
Airflow rate(H/M/L)	m ³ /h	4700/4100/3599	4700/4100/3599	4700/4100/3599	7180/6150/4600	7180/6150/4600
	CFM	2766/2413/2118	2766/2413/2118	2766/2413/2118	4226/3620/2708	4226/3620/2708
External static pressure(Min/Std/Max)	Pa	50/200/280	50/200/280	50/200/280	50/200/280	50/200/280
Sound pressure level(H/M/L)	dB(A)	59/55/52	59/55/52	59/55/52	61/59/56	61/59/56
Net dimension(WxHxD)	mm(in.)	56-13/16x18-1/2x31-57/64(1443x470x810)			77-9/16x15-3/4x35-17/32(1970x668x902.5)	
Packing dimension(WxHxD)	mm(in.)	59-13/32x21-21/32x38-31/32(1509x550x990)			82-31/64x31-1/2x37-61/64(2095x800x964)	
Net/gross weight	kg(lbs.)	254/284(115/129)			518/551(235/250)	
Piping connections	Liquid/gas pipe	mm(in.) Φ9.53/Φ15.9x2/(Φ3/8/Φ5/8)x2				Φ9.53/Φ22.2x2/(Φ3/8/Φ7/8)x2
	Drain piping	mm(in.) Φ32(OD 1-17/64)				
Standard controller		Wired controller KJR-29B1/BK-E (6 meters connection wire)				

Notes:
 1. Nominal cooling capacities are based on the following conditions: return air temp.: 27°C(80.6°F)DB, 19°C(66.2°F)WB, outdoor temp.: 35°C(95°F)DB, equivalent ref. piping: 8m(26.25ft.) (horizontal).
 2. Nominal heating capacities are based on the following conditions: return air temp.: 20°C(68°F)DB, outdoor temp.: 7°C (44.6°F)DB, 6°C(42.8°F)WB, equivalent ref. piping: 8m(26.25ft.) (horizontal).
 3. Sound Level is measured 1.4m(4.59ft.) below the unit.
 * External static pressure is based on high speed indoor air flow.

Wall-mounted



Convenient Installation >>

Multi-directional refrigerant outlet pipe: left/right/rear, more flexible for installation.

EXV is built-in the indoor unit, compact size, lengthened the connection pipe; gas pipe: 468mm(18-27/64in.); liquid pipe: 550mm(21-21/32in.), more flexible for installation.

Adopts new type fixing plate, stable and easy to install.

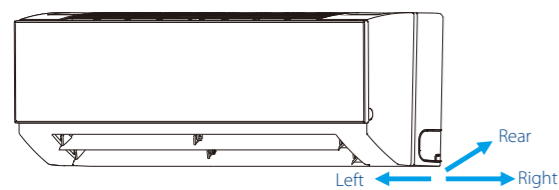

Auto Swing Louver >>

The Auto Swing Louver function ensures that the air direction corresponds to the mode selected.

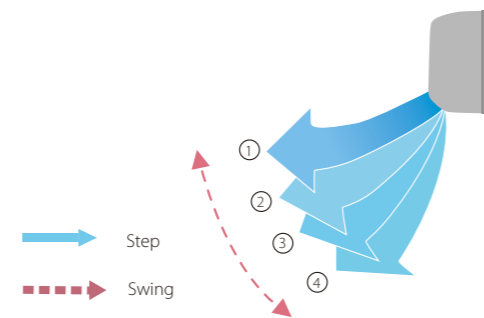

Optimal Comfort Through Better Flow Control and Quiet Operations >>

The mechanical expansion valve offers 2,000-stage element positioning to ensure precise flow control and less modulation noise when the EXV is operating for a quiet and comfortable environment. Three air flow speeds: low, medium and high; double air guides. Smoother airflow and less turbulence is ensured by the multi-blade fan and the air guide design.



Specification

Model		MDV-D71G-R3/QN1Y	MDV-D80G-R3/QN1Y	MDV-D90G-R3/QN1Y
Power supply		1-phase, 220-240V, 60Hz		
Cooling capacity	kW	7.1	8.0	9.0
	Btu/h	24200	27300	30700
Heating capacity	kW	8.0	9.0	10.0
	Btu/h	27300	30700	34100
Power input	Cooling W	79	95	95
	Heating W	79	95	95
Airflow rate(H/M/L)	m ³ /h	1190/780/580	1320/840/640	1320/840/640
	CFM	700/459/341	776/494/376	776/494/376
Sound pressure level(H/M/L)	dB(A)	45/42/39	48/43/38	49/43/38
Net dimension(WxHxD)	mm(in.)	1250x325x245(49-7/32x12-51/64x9-41/64)		
Packing dimension(WxHxD)	mm(in.)	1345x430x335(52-61/64x16-59/64x13-3/16)		
Net/gross weight	kg(lbs.)	19.9/25(43.8/55.1)		
Piping connections	Liquid/gas pipe mm(in.)	Φ9.53/Φ15.9(Φ3/8/Φ5/8)		
	Drain piping mm(in.)	Φ16.5(OD 21/32)		
Standard controller		Wireless remote controller RM05/BG(T)E-A		

Model		MDV-D22G/N1-S	MDV-D28G/N1-S	MDV-D36G/N1-S	MDV-D45G/N1-S	MDV-D56G/N1-S
Power supply		1-phase, 220-240V, 60Hz				
Cooling capacity	kW	2.2	2.8	3.6	4.5	5.6
	Btu/h	7500	9600	12300	15400	19100
Heating capacity	kW	2.4	3.2	4.0	5.0	6.3
	Btu/h	8200	10900	13600	17100	21500
Power input	Cooling W	28	28	28	51	51
	Heating W	28	28	28	51	51
Airflow rate(H/M/L)	m ³ /h	525/480/430	525/480/430	590/520/480	860/755/630	925/860/755
	CFM	309/283/253	309/283/253	347/306/283	506/444/371	544/506/444
Sound pressure level(H/M/L)	dB(A)	35/32/29	35/32/29	35/32/29	40/38/34	40/38/34
Net dimension(WxHxD)	mm(in.)	915x290x230(36-1/32x11-13/32x9-1/16)		1072x315x230(42-7/32x12-13/32x9-1/16)		
Packing dimension(WxHxD)	mm(in.)	1020x390x315(40-5/32x15-11/32x12-13/32)		1180x415x315(46-15/32x16-11/32x12-13/32)		
Net/gross weight	kg(lbs.)	13/16.8(28.7/37.1)		15.1/19.5(33.4/43)		
Piping connections	Liquid/gas pipe mm(in.)	Φ6.35/Φ12.7(Φ1/4/Φ1/2)			Φ9.53/Φ15.9(Φ3/8/Φ5/8)	
	Drain piping mm(in.)	Φ16.5(OD 21/32)				
Standard controller		Wireless remote controller RM05/BG(T)E-A				

Model		MDV-D22G/N1YB	MDV-D28G/N1YB	MDV-D36G/N1YB	MDV-D45G/N1YB	MDV-D56G/N1YB
Power supply		1-phase, 220-240V, 60Hz				
Cooling capacity	kW	2.2	2.8	3.6	4.5	5.6
	Btu/h	7500	9600	12300	15400	19100
Heating capacity	kW	2.4	3.2	4.0	5.0	6.3
	Btu/h	8200	10900	13600	17100	21500
Power input	Cooling W	28	28	28	45	45
	Heating W	28	28	28	45	45
Airflow rate(H/M/L)	m ³ /h	557/520/467	557/520/467	557/520/467	842/722/597	842/722/597
	CFM	328/306/275	328/306/275	328/306/275	496/425/351	496/425/351
Sound pressure level(H/M/L)	dB(A)	35/32/29	35/32/29	35/32/29	40/38/34	40/38/34
Net dimension(WxHxD)	mm(in.)	915x290x210(36-1/32x11-13/32x8-9/32)			1070x315x210(42-7/32x12-13/32x8-9/32)	
Packing dimension(WxHxD)	mm(in.)	1020x385x300(40-5/32x15-5/32x11-13/16)			1165x395x285(45-7/8x15-9/16x11-7/32)	
Net/gross weight	kg(lbs.)	12/17.5(26.5/38.6)			15/19(33.1/41.9)	
Piping connections	Liquid/gas pipe mm(in.)	Φ6.35/Φ12.7(Φ1/4/Φ1/2)			Φ9.53/Φ15.9(Φ3/8/Φ5/8)	
	Drain piping mm(in.)	Φ16.5(OD 21/32)				
Standard controller		Wireless remote controller RM05/BG(T)E-A				

Notes:

- Nominal cooling capacities are based on the following conditions: return air temp.: 27°C(80.6°F)DB, 19°C(66.2°F)WB, outdoor temp.: 35°C(95°F)DB, equivalent ref. piping: 8m(26.25ft.) (horizontal).
- Nominal heating capacities are based on the following conditions: return air temp.: 20°C(68°F)DB, outdoor temp.: 7°C(44.6°F)DB, 6°C(42.8°F)WB, equivalent ref. piping: 8m(26.25ft.) (horizontal).
- Sound level is measured 1m(3.28ft.) below the air out-let both horizontally and vertically.

Ceiling & Floor



Convenient Installation >>

The slim and sleek structure design ensures easy installation. It can be installed into a corner of the ceiling even if the ceiling is very narrow.

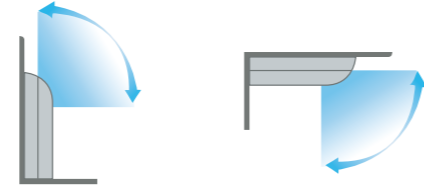
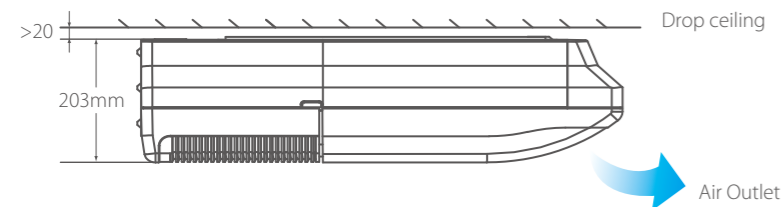

The unit can be installed either horizontally on the ceiling or vertically against the wall.

Auto Swing and Wide Angle Air Flow >>

Two direction auto swing - vertical and horizontal. The range of horizontal air discharge is widened which secures wider air flow distribution to provide more comfortable air circulation no matter where the unit is set up. Three air flow speeds: low, medium and high; double air guides.

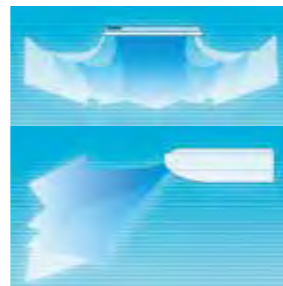

Auto Swing & Wide-angle Airflow

More Comfortable >>

Adopts electrical expansion valve, ensuring precise flow control, lower modulation noise when EXV is operating. Low noise operations; minimum 36 dB(A). Smoother airflow and less turbulence due to the multi-blade fan and the air guide design.

Specification

Model		MDV-D36DL/N1-C	MDV-D45DL/N1-C	MDV-D56DL/N1-C	MDV-D71DL/N1-C
Power supply		1-phase, 220-240V, 60Hz			
Cooling capacity	kW	3.6	4.5	5.6	7.1
	Btu/h	12300	15400	19100	24200
Heating capacity	kW	4.0	5.0	6.3	8.0
	Btu/h	13600	17100	21500	27300
Power input	Cooling	W	50	148	148
	Heating	W	50	148	148
Airflow rate(H/M/L)	m ³ /h	600/480/400	750/650/550	750/650/550	750/650/550
	CFM	353/283/235	441/383/324	441/383/324	441/383/324
Sound pressure level(H/M/L)	dB(A)	40/38/36	43/41/38	43/41/38	43/41/38
Net dimension(WxHxD)	mm(in.)	990x203x660(38-31/32x7-63/64x25-63/64)			
Packing dimension(WxHxD)	mm(in.)	1089x296x744(42-7/8x11-21/32x29-9/32)			
Net/gross weight	kg(lbs.)	26/32(57.3/70.6)	28/34(61.7/75.0)	28/34(61.7/75.0)	28/34(61.7/75.0)
Piping connections	Liquid/gas pipe	mm(in.)	Φ6.35/Φ12.7(Φ1/4/Φ1/2)		Φ9.53/Φ15.9(Φ3/8/Φ5/8)
	Drain piping	mm(in.)	Φ16(OD 5/8)		
Standard controller		Wireless remote controller RM05/BG(T)E-A			

Model		MDV-D80DL/N1-C	MDV-D90DL/N1-C	MDV-D112DL/N1-C	MDV-D140DL/N1-C	MDV-D160DL/N1-C
Power supply		1-phase, 220-240V, 60Hz				
Cooling capacity	kW	8.0	9.0	11.2	14.0	16.0
	Btu/h	27300	30700	38200	47800	54600
Heating capacity	kW	9.0	10.0	12.5	15.0	18.0
	Btu/h	30700	34100	42700	51200	61400
Power input	Cooling	W	183	183	245	245
	Heating	W	183	183	245	245
Airflow rate(H/M/L)	m ³ /h	1,200/900/700	1,200/900/700	1,980/1,860/1,730	1,980/1,860/1,730	2,300/2,100/1,800
	CFM	706/530/412	706/530/412	1,165/1,095/1,018	1,165/1,095/1,018	1,354/1,236/1,060
Sound pressure level(H/M/L)	dB(A)	45/43/40	45/43/40	47/45/42	47/45/42	47/45/42
Net dimension(WxHxD)	mm(in.)	1280x203x660(50-25/64x7-63/64x25-63/64)		1670x244x680(65-3/4x9-39/64x26-49/64)		1670x285x680(65-3/4x11-7/32x26-49/64)
Packing dimension(WxHxD)	mm(in.)	1379x296x744(54-19/64x11-21/32x29-19/64)		1764x329x760(69-29/64x12-61/64x29-59/64)		1775x377x760(69-7/8x14-27/32x29-59/64)
Net/gross weight	kg(lbs.)	34.5/41(76.1/90.4)		54/59(119.0/130.1)		57.5/63.5(126.5/139.7)
Piping connections	Liquid/gas pipe	mm(in.) Φ9.53/Φ15.9(Φ3/8/Φ5/8)				
	Drain piping	mm(in.) Φ16(OD 5/8)				
Standard controller		Wireless remote controller RM05/BG(T)E-A				

Notes:

- Nominal cooling capacities are based on the following conditions: return air temp.: 27°C(80.6°F)DB, 19°C(66.2°F)WB, outdoor temp.: 35°C(95°F)DB, equivalent ref. piping: 8m(26.25ft.) (horizontal).
- Nominal heating capacities are based on the following conditions: return air temp.: 20°C(68°F)DB, outdoor temp.: 7°C(44.6°F)DB, 6°C(42.8°F)WB, equivalent ref. piping: 8m(26.25ft.) (horizontal).
- Floor standing : Sound level is measured 1m(3.28ft.) horizontally and 1m(3.28ft.) vertically from the air-outlet. Ceiling mounted: Sound level is measured 1m(3.28ft.) horizontally and 1m(3.28ft.) vertically from the air-outlet.

Fresh Air Processing Unit



100% Fresh Air Processing Unit >>

Both fresh air filtration and heating/cooling can be achieved in a single system. Indoor units and fresh air processing unit can be connected to the same refrigerant system, increasing design flexibility and greatly reducing total system costs.

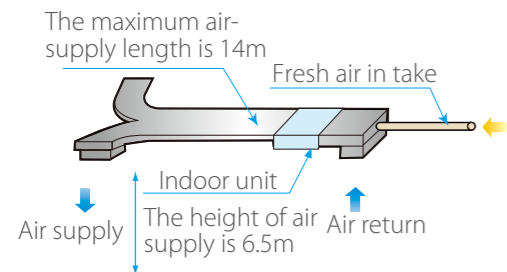

High External Static Pressure >>

External static pressure can be up to 196Pa(models 125 to 140) and 280Pa(models 200 to 280) for more flexible duct applications. The maximum length of air supply is around 14m(45.9ft) and the maximum height of air supply is about 6.5m(21.3ft).

Healthy and Comfortable >>

Fresh air is imported, providing a healthy and comfortable living environment. Four speed fan motor(model 125&140).

Innovative air supply technology for excellent room temperature control >>

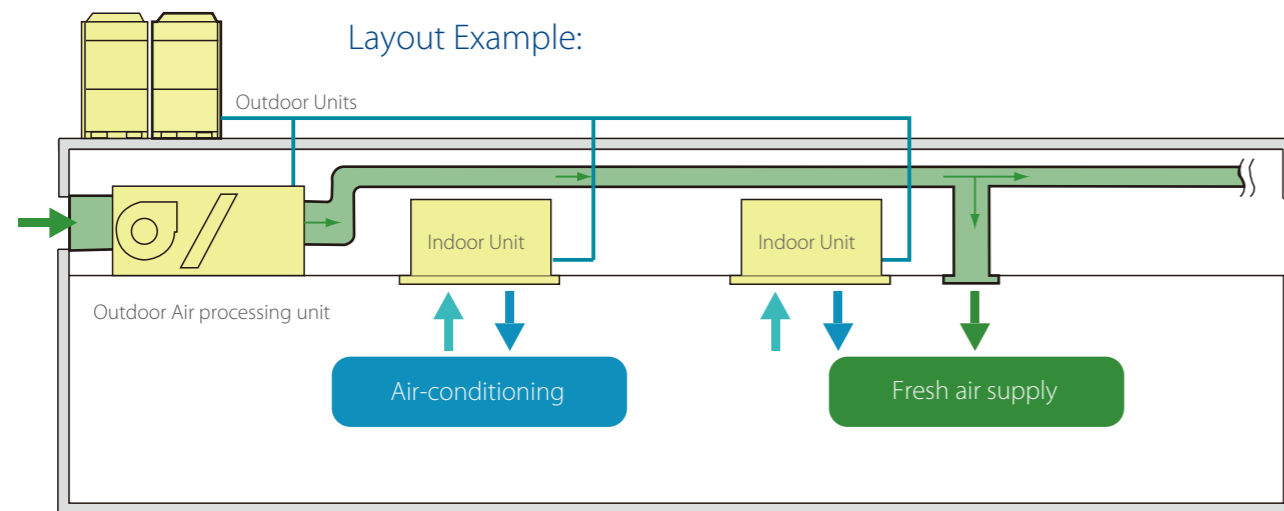

Specification

Model		MDV-D125T1/VN1-FA	MDV-D140T1/VN1-FA	MDV-D200T1/VN1-FA	MDV-D250T1/VN1-FA	MDV-D280T1/VN1-FA
Power supply		1-phase,208-230V,60Hz				
Cooling capacity	kW	12.5	14.0	20.0	25.0	28.0
	Btu/h	42600	47800	68200	85300	95500
Heating capacity	kW	10.5	12.0	18.0	20.0	22.0
	Btu/h	36000	41000	61400	68200	75000
Power input	Cooling W	468	468	616	616	616
	Heating W	468	468	616	616	616
Airflow rate(H/M/L)	m³/h	2142/1870/1611	2142/1870/1611	2870/2620/2150	3005/2700/2250	3005/2700/2250
	CFM	1261/1101/948	1261/1101/948	1689/1542/1265	1766/1589/1324	1766/1589/1324
External static pressure(Min/Std/Max)	Pa	30/50/196	30/50/196	50/200/280	50/200/280	50/200/280
Sound pressure level(H/M/L)	dB(A)	54/52/50	53/50/48	54/53/51	55/54/52	55/54/52
Net dimension(WxHxD)	mm(in.)	1300x420x690(51-3/16x16-17/32x27-11/64)			1443x470x810(56-13/16x18-1/2x31-57/64)	
Packing dimension(WxHxD)	mm(in.)	1436x450x768(56-17/32x17-23/32x30-1/4)			1509x550x990(59-13/32x21-21/32x38-31/32)	
Net/gross weight	kg(lbs.)	69.5/76(153.2/167.5)			114/124(251/274)	
Piping connections	Liquid/gas pipe mm(in.)	Φ9.53/Φ15.9/(Φ3/8/Φ5/8)				
	Drain piping mm(in.)	Φ25(OD 63/64)			Φ32(OD 1-17/64)	
Standard controller		Wired controller KJR-29B1/BK-E (6 meters connection wire)				

Notes:

- Nominal cooling capacities are based on the following conditions: return air temp.: 27°C(80.6°F)DB, 19°C(66.2°F)WB, outdoor temp.: 35°C(95°F)DB, equivalent ref. piping: m(26.25ft.) (horizontal).
 - Nominal heating capacities are based on the following conditions: return air temp.: 20°C(68°F)DB, outdoor temp.: 7°C (44.6°F)DB, 6°C(42.8°F)WB, equivalent ref. piping: 8m(26.25ft.) (horizontal).
 - Sound Level is measured 1.4m(4.59ft.) below the unit.
- * External static pressure is based on high speed indoor air flow.
- Connection Conditions:
The following restrictions must be observed in order to maintain the indoor units connection to the same system.
- * When outdoor-air processing units are connected, the total connection capacity must be within 50% to 100% of that of the outdoor units.
 - * When outdoor-air processing units and standard indoor units are connected, the total connection capacity of the outdoor-air processing units must not exceed 30% that of the outdoor units.
 - * Outdoor-air processing units can be used without indoor units.
 - * The fresh air processing unit is not available for V4+R system & 8~26kW side discharge outdoor units.



Control Systems

Wireless Remote Controller

- RM02
- RM05

Wired Controller

- KJR-29B
- KJR-90C
- KJR-86C
- KJR-10B
- KJR-12B
- KJR-120B
- KJR-120C
- KJR-27B

Centralized Controller & Monitor

- CCM30
- MD-CCM03
- MD-CCM09
- KJR-90B
- MD-CCM02

Network Control Software & Gateways

- IMM Software & M-Interface
- Data Converter CCM15
- KNX Gateway MD-KNX
- BACnet Gateway CCM08
- LonWorks Gateway LonGW64
- Modbus Gateway CCM-18A

Accessories

- Hotel Key Card Interface Module MD-NIM05
- Infrared Sensor Controller MD-NIM09
- 3-Phase Protector
- Digital Power Ammeter
- Indoor Unit Group Controller-KJR-150A
- Remote Alarm Controller KJR-32B
- Network Electricity Distribution Module MD-NIM10
- AHU Control Box
- TGM Outdoor Unit Diagnosis

Wireless Remote Controller



Auto Mode >>

Auto mode is specially designed for V4+R system.

Can automatically switch between cooling and heating mode based on the temperature difference between the indoor temperature and set temperature.

* Runs cooling mode only for the 2-pipe system.

Background Light >>

The background light allows users to operate the device in a dark room. The device lights up when a button is pressed, and turns off when a given operation is completed.

Address Setting >>

In addition to the machine's auto addressing function, users can set the indoor unit's address on the wireless remote controller RM05/RM02.



Follow Me >>

With the follow me function, the temperature sensor built-in to the remote controller automatically adjusts temperature and sends it to the indoor unit, making the room more comfortable.

*The Follow Me function is available in RM02.



Benefits

Model name	RM02	RM05
Mode change	●	●
Temp. setting	●	●
Fan speed control	●	●
Keyboard lock	●	●
Eco operation	●	●
Swing function	●	●
Air direction	●	●
24h timer	●	●
Clock display	—	●
Address setting	●	●
Follow me function	●	—
26°C shortcut setting	●	—
Background light	●	●

Notes:

1. The ECO function needs to match with the corresponding indoor units.
2. ● : available — : unavailable

Specifications

Model	RM02	RM05
Dimensions (HxWxD)(mm)	150x60x15	150x65x20
Power (V)		1.5V(LR03/AAA)X2

Wired Controller



KJR-86C KJR-29B KJR-90C

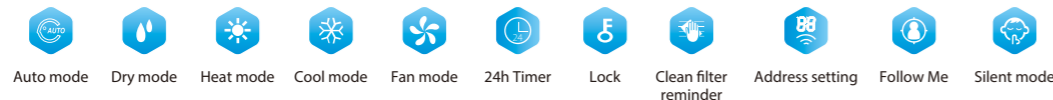

Clean Filter Reminder >>

The wired controller records the total running time of the indoor unit. When the accumulated running time reaches the pre-set value, the system will remind users to clean the indoor unit's filter. Cleaning the filter regularly keep indoor air fresh, clean and good for your health.



Silent Mode >>

In cooling, heating and auto mode, operating silent mode can lower running noise by setting the fan speed to low for a quieter environment.



Keyboard Locking >>

The locking function can be used to prevent other people from using the controller.

Remote Signal Receiving Function >>

KJR-29B and KJR-90C provide a signal receiver for the remote controller. Signals from the remote control can be received by a wired controller, then sent to the indoor unit for easy control.

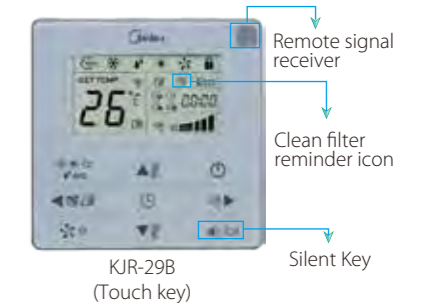

Address Setting >>

KJR-29 and KJR-90C have an address setting function. Service personnel can set the address for the indoor unit for easy installation and future maintenance.



Follow Me >>

The temperature sensor built-in to the wired controller senses the surrounding temperature and adjusts the room temperature for perfect comfort.

*The Follow Me function is available in KJR-29B and KJR-90C.



One-key 26°C >>

KJR-86C has a one-key 26°C function. For saving energy and remaining comfortable, 26°C is the ideal temperature.



User Friendly Design >>

KJR-86C is a hidden mode controller specially designed for hotels, hospitals, schools and other similar types of buildings.

Hidden mode key controller:

Press the temperature buttons "▲" and "▼" simultaneously for 3 seconds to select the operation mode: COOL or HEAT.

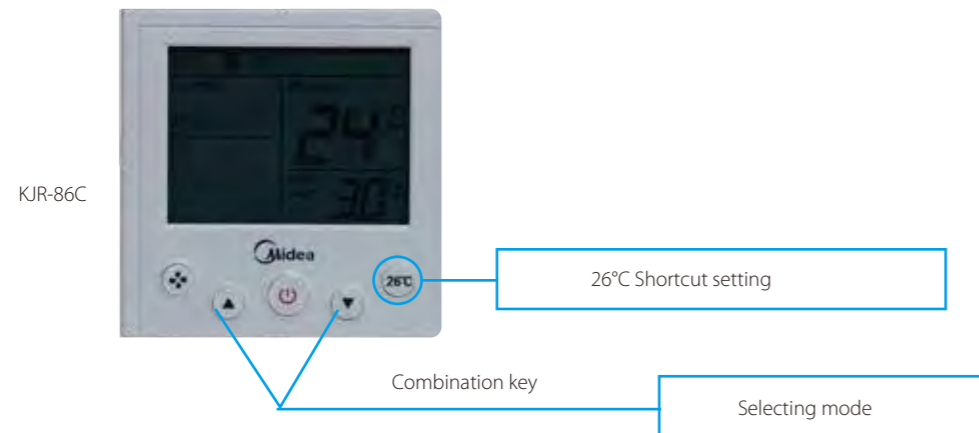

User Friendly Installation >>

The background light function makes it easy to use in the dark. As small as an electric switch, the installation effect more attractive.



Auto Restart Function >>

If the power fails, the system records running parameters such as: ON/OFF state, mode, Fan speed, Temperature, Swing and Locking status. When powered on again, the system automatically checks the status before the failure.

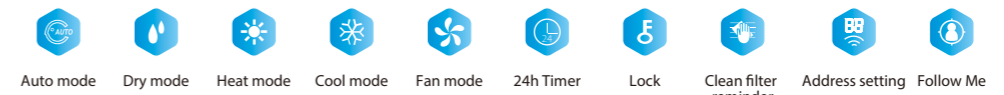

Built-in Timer >>

The built-in daily timer offers automatically starts and stops the system at set times based on user needs.

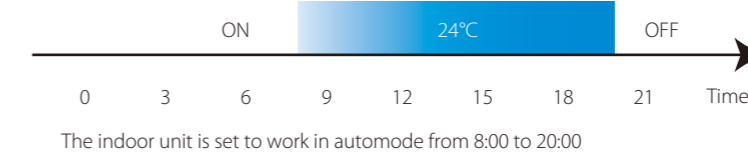

Follow Me >>

The FOLLOW ME function enables the wired controller to detect the air temperature at the user's height instead of the ceiling or floor for accurate temperature configuration.

*The Follow Me function is available in KJR-12B.

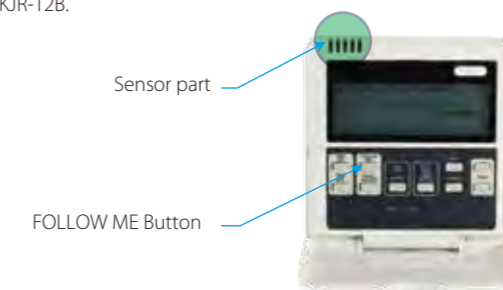

Addresses Setting >>

The address setting function is coupled with easy installation and simple future maintenance. Service personnel can set the address for the indoor unit using KJR-10B, KJR-29B and KJR-90C.



Easy Connection >>

The wired controller conveniently connects to the indoor unit's display panel via connecting wire.

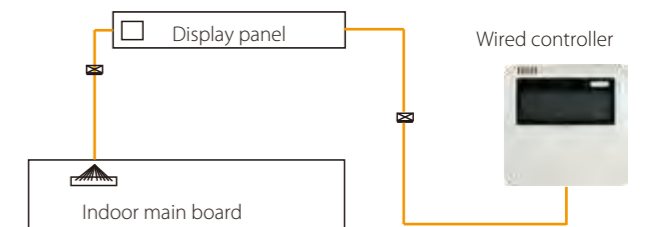

V4 Plus R Wired Controller



Auto Mode >>

Auto mode is specially designed for the V4 plus R series. In auto mode, the V4 plus R system can automatically switch between COOL or HEAT mode according to the temperature difference between Tf (indoor temperature) and Ts (setting temperature).
* KJR-120B is compatible with the 2-pipe system. In auto mode, it only can run in cooling mode.

Error Display >>

If a malfunction occurs, the temperature setting display area will show the error code. The error status can be checked easily on the indoor unit's wired controller.

Filter Cleaning Reminder >>

The wired controller records the total running time of the indoor unit. When the accumulated running time reaches the pre-set value, it will remind you to clean the air filter. Cleaning the filter regularly keeps the indoor air fresh and clean, and is good for your health.

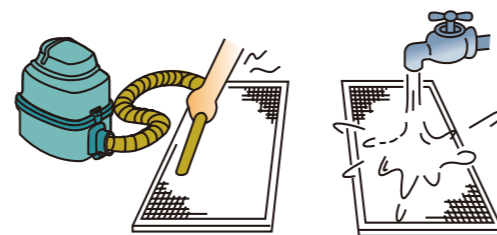

Silent Mode >>

In cooling, heating, and auto mode, silent mode reduces the running noise by setting the fan speed to low so you can enjoy peace and quiet while remaining comfortable.



Weekly Schedule Timer Wired Controller



Simple Design >>

Weekly schedule wired controller can query the indoor temperature and the set parameters of the weekly schedule. It can show the error codes and running state of the indoor unit. The LCD backlight enables users to operate the device in the dark.

Weekly Schedule Timer >>

The weekly schedule timer function allows users to set up to four scheduled periods per day for frequent adjustments. The Schedule feature allows you to program device behavior. If a device must follow a certain schedule, you can program the device to operate only at the scheduled times. Scheduled devices do not activate unless programmed to do so. They are centrally managed, significantly reducing energy consumption.

Delay Function >>

This function is specifically designed for people who work overtime. Pressing the Delay button postpones system shutdown by 1 or 2 hours.

Error Display >>

If a malfunction occurs, the temperature setting display area will show the error code. The error status can be checked easily on the indoor unit's wired controller.



°F/°C Switch >>

Press the left-right and up-down buttons simultaneously for three seconds to switch between °F and °C.

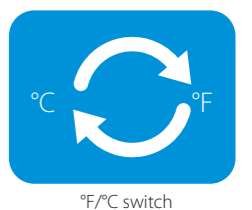

°F/°C switch

HRV Wired Controller



KJR-27B is individually designed for HRV—Heat Recovery Ventilator. The HRV can work in the following modes: exhaust, air supply, bypass, heat exchange, and auto.

Built-in Timer >>



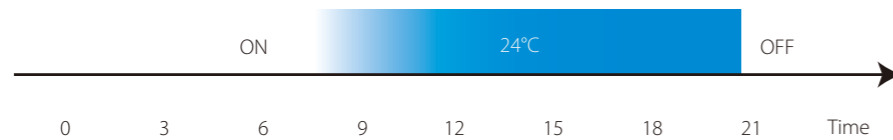



Built-in daily timer offers the convenience of automatically starting and stopping the HRV at the times set
 Setup screen example
 Set to Wednesday: 8:00 to 20:00



Specifications

Model	KJR-29B	KJR-90C	KJR-86C	KJR-10B	KJR-12B	KJR-27B	KJR-120B	KJR-120C
Dimensions (HxWxD)(mm)	120x120x20	86x86x16.5	86x86x18	120x120x15	120x120x15	120x120x15	120x120x20	120x120x20
Power (V)	DC 5V (Supplied by indoor unit)						DC 12V by IDU	

Benefits

Model name							
	KJR-10B	KJR-12B	KJR-29B	KJR-90C	KJR-86C	KJR-120B	KJR-120C
Fan speed control	●	●	●	●	●	●	●
Mode change	●	●	●	●	●	●	●
Auto mode for V4+R	—	—	—	—	—	●	—
Eco mode	●	●	—	—	—	—	—
Keyboard lock	●	●	●	●	—	●	●
Swing function	●	●	●	●	—	●	●
Background-light	—	●	●	●	●	●	●
24h timer	●	●	●	●	—	●	●
Clock display	●	—	●	●	—	●	●
Address setting	●	—	●	●	—	—	—
Receiving remote signal	—	—	●	●	—	—	—
Clean filter reminder	—	—	●	●	—	●	—
Follow me function	—	●	●	●	—	—	—
Silent mode	—	—	●	●	●	●	—
26°C shortcut setting	—	—	—	—	●	—	—
Display indoor temp.	—	—	—	—	●	—	—
°F/°C initial setting	●	—	●	●	—	●	●
Weekly schedule timer	—	—	—	—	—	—	●
Delay function	—	—	—	—	—	—	●
Auto restart	●	●	●	●	●	●	●
Error code display	—	—	—	—	—	●	●

Notes:

1. ECO function needs to match with the corresponding indoor units.
2. ● : available — : unavailable

Centralized Controller & Monitor



Indoor Centralized Controller



CCM30
MD-CCM03
MD-CCM09

- Swing
- Heat mode
- Cool mode
- Fan mode
- 24h Timer
- Keyboard lock
- Remote controller lock
- Cooling lock
- Heating lock
- Dry mode
- Weekly schedule
- Clean filter reminder
- Network access

Centralized Control >>

The centralized controller is a multifunctional device that can control up to 64 indoor units within a maximum connection length of 1,200m. User can group control or individual control and the set temperature of each unit can also differ.

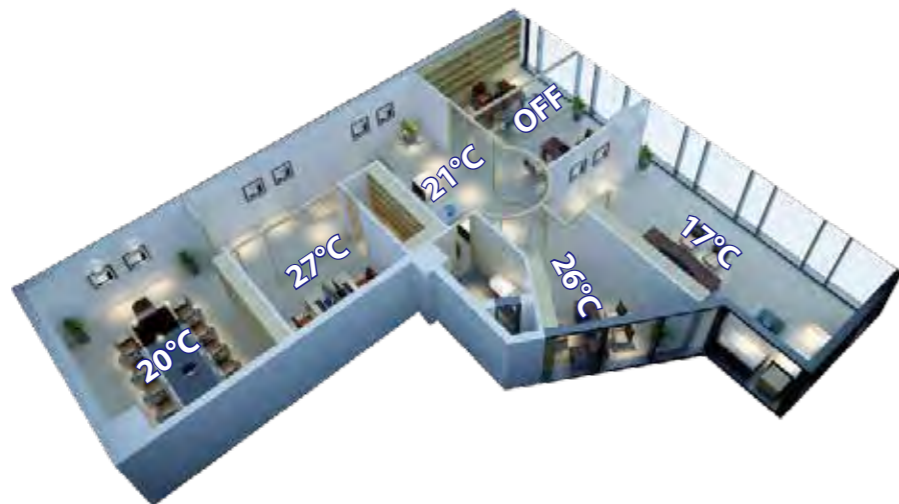

Three Lock Modes >>

The centralized controller is a better way to manage indoor units. Users can choose to lock the wireless controller, running mode, or the centralized controller's keyboard.



Wiring Example >>

The device connects to the master outdoor units of Midea's newly designed products to simplify and centralize the wiring configuration. The two connection methods are as follows:

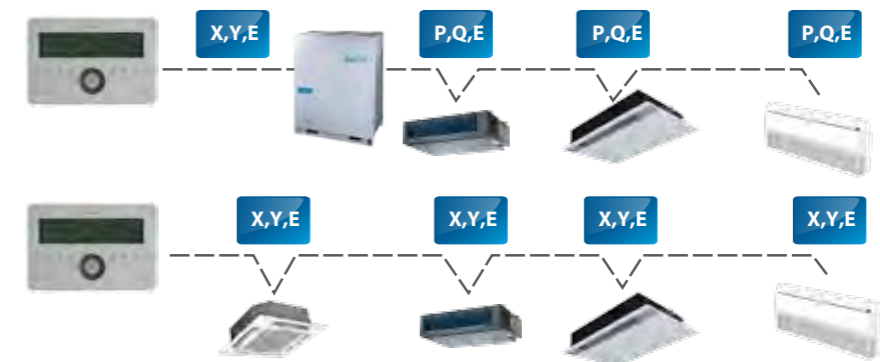

*1. If it connects to XYE ports of master ODU, the ODU must be set to auto addressing mode.
*2. Some products can only be connected with MD-CCM09 from indoor side XYE ports.

Application Example >>

Ensure the address is not repeated. Units can be from different systems, with up to 64 indoor units. This greatly reduces system limitations.

*1. For the 2-pipe system, the running mode should be in the same mode.
*2. For 3-pipe system, the running mode can be set as required.



Air Filter Cleaning Reminding Function >>

CCM30 is a new design and touch key controller. The reminder to clear the filter is only available on the touch-key central controller CCM30. The "FL" icon indicates that the air filter in a given indoor unit needs cleaning.

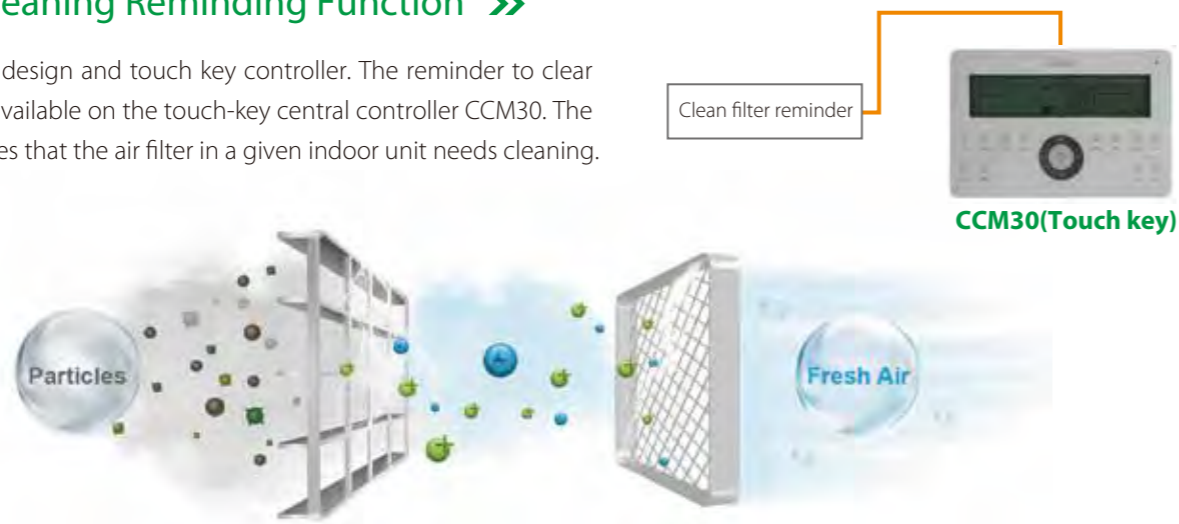

Easy Installation >>

The centralized controller offers two installation modes. Unlike the B structure, the A structure must be embedded into the wall. Both are easy to operate.



*A and B structure is available for CCM30

Stylish Design >>

CCM's stylish design suits high-end environments. The keyboard lock function is used to prevent operating mistakes.



Weekly Schedule for MD-CCM09 >>

MD-CCM09 is a weekly centralized controller. It can control 64 indoor units in a weekly schedule. Users can set up to four periods per day, and select the desired running mode and room temperature. The operating object can be a single indoor unit or all the indoor units.

	8:00	16:00	23:59
Sun	28°C	22°C	24°C
Mon	26°C	22°C	23°C
Tue	26°C	22°C	23°C
Wed	26°C	22°C	23°C
Thu	26°C	22°C	26°C
Fri	26°C	22°C	26°C
Sat	28°C	off	24°C

Single/Unified Control Mode >>

The control object can either be a single unit or all units, which vastly simplifies the control process. Operation signal feedback ensures that all units are working in the correct mode.

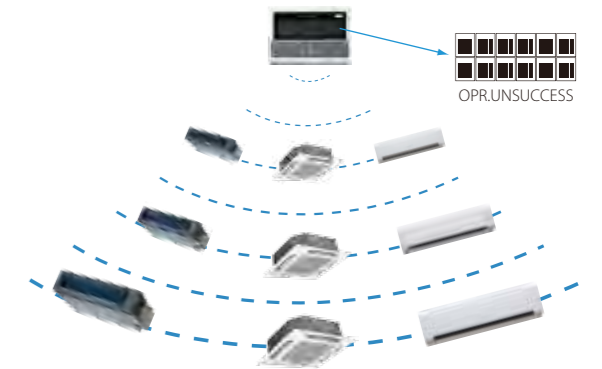

Indoor Unit Working Status Display >>

Displays indoor units' working status and error codes, so users can easily identify faults by checking the error code table in the user's manual before contacting a service engineer.

Error code or protection code

Connecting status matrix

Current	Set. temp	Mode	Auto	Query Set Opr. unsuccess																																																																															
88#	88°C	ALL	Auto	<table border="1" style="width: 100%; text-align: center;"> <tr><td>00</td><td>01</td><td>02</td><td>03</td><td>04</td><td>05</td><td>06</td><td>07</td><td>08</td><td>09</td><td>10</td><td>11</td><td>12</td><td>13</td><td>14</td><td>15</td></tr> <tr><td>16</td><td>17</td><td>18</td><td>19</td><td>20</td><td>21</td><td>22</td><td>23</td><td>24</td><td>25</td><td>26</td><td>27</td><td>28</td><td>29</td><td>30</td><td>31</td></tr> <tr><td>32</td><td>33</td><td>34</td><td>35</td><td>36</td><td>37</td><td>38</td><td>39</td><td>40</td><td>41</td><td>42</td><td>43</td><td>44</td><td>45</td><td>46</td><td>47</td></tr> <tr><td>48</td><td>49</td><td>50</td><td>51</td><td>52</td><td>53</td><td>54</td><td>55</td><td>56</td><td>57</td><td>58</td><td>59</td><td>60</td><td>61</td><td>62</td><td>63</td></tr> </table>																00	01	02	03	04	05	06	07	08	09	10	11	12	13	14	15	16	17	18	19	20	21	22	23	24	25	26	27	28	29	30	31	32	33	34	35	36	37	38	39	40	41	42	43	44	45	46	47	48	49	50	51	52	53	54	55	56	57	58	59	60	61	62	63
00	01	02	03																	04	05	06	07	08	09	10	11	12	13	14	15																																																				
16	17	18	19																	20	21	22	23	24	25	26	27	28	29	30	31																																																				
32	33	34	35																	36	37	38	39	40	41	42	43	44	45	46	47																																																				
48	49	50	51	52	53	54	55	56	57	58	59	60	61	62	63																																																																				
88:80	88:80	ON	OFF																																																																																
88:80	88:80	ON	OFF																																																																																
88	18	28	28:88	Weekly Timer Off																																																																															
Year	Mon	Day																																																																																	



Access to Network Monitoring >>

The centralized controller can connect up to 64 indoor units on the network monitoring and building management systems.



*If it connects to XYE ports of master ODU, the ODU must be set to auto addressing mode. Network access is only available for CCM03 and CCM30

Benefits

Model			
Max. number of indoor units	64	64	64
Group control	●	●	●
Individual control	●	●	●
Fan speed control	●	●	●
Mode selection	●	●	●
Mode lock	●	●	●
Remote controller lock	●	●	●
Keyboard lock	●	●	●
Weekly schedule timer	—	—	●
24h timer	●	●	●
Error check	●	●	●
Emergency start	●	●	●
Emergency stop	●	●	●
Background light	●	●	●
Swing function	●	●	●
Air filter cleaning reminder	●	—	—
Parameter query	●	●	●
BMS access	●	●	—

Notes:

● : available — : unavailable

Specifications

Model	MD-CCM03	CCM30	MD-CCM09
Dimensions (H*W*D)(mm)	179x119x74	180x122x78 and 180x122x68	179x119x74
Power (V)	198-242V(50/60Hz)		

Unified On/Off Controller

Stylish unified controller design with a clear panel.
Can control single or group indoor units.



KJR-90B

Unified Control >>

KJR-90B offers on/off and heating/cooling functions for indoor units based on preset temperatures to ensure easy management.



Centralized Control >>

KJR-90B can be used to centrally control up to 16 indoor units.

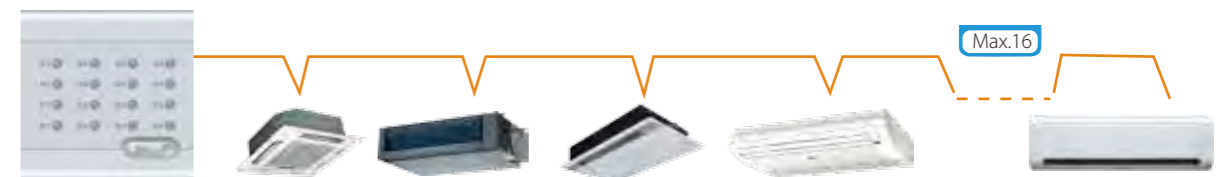

Light Indicator >>

The LEDs on KJR-90B indicate indoor units' running status for easy fault detection. The lights switch off automatically to save energy once an action is completed. The indicators are as follows:

Light	Blue	Red	Flash
Single On/Off key	Cooling/Fan	Heating	IDU Error
Unified On/Off key			EEPROM Error

Easy Installation >>

KJR-90B can be easily mounted on the built-in cabinet:

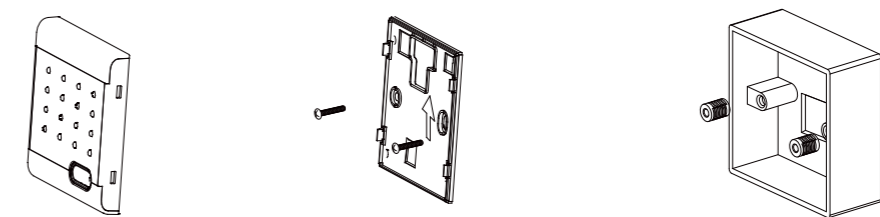

Specifications

Model	KJR-90B
Dimensions (H*W*D)(mm)	90x86x8
Power (V)	DC 5V(Supplied by indoor unit)

Outdoor Centralized Monitor

MD-CCM02



- Query parameters
- Power consumption
- Protection/ Error codes
- Communication by ODU
- Communication by PC
- Forced Cooling

ODU Parameters Display >>

MD-CCM02 enables users to easily check outdoor units' running status, including frequency, temperature, current, pressure, protection codes and error codes.

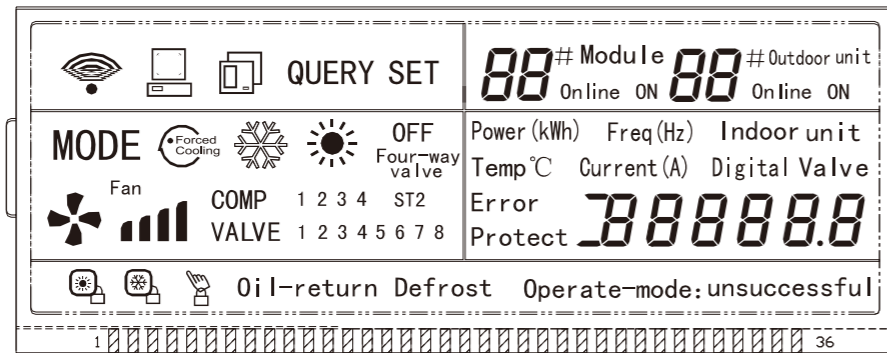

Graph 2 LCD Screen

Access to Network Monitoring >>

MD-CCM02 can connect up to 8 refrigerant systems and 32 outdoor units to the network system.

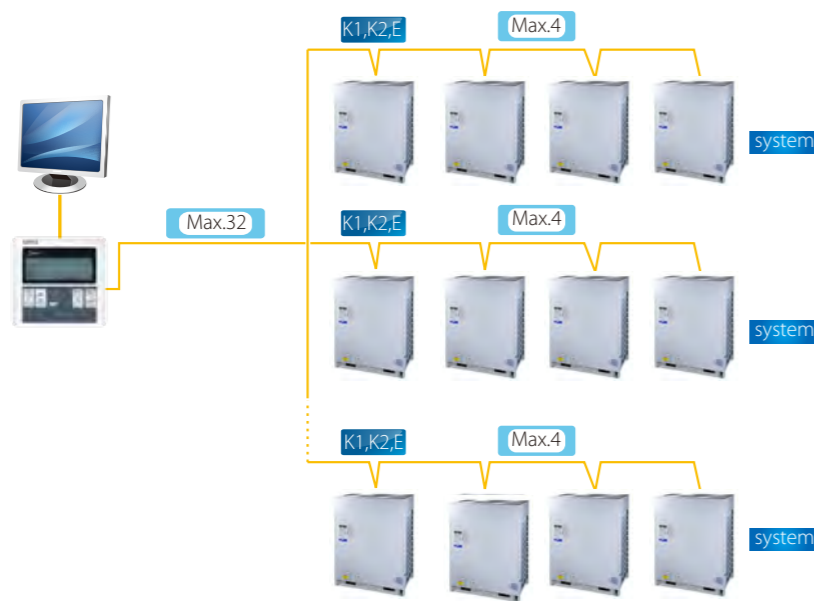

Specifications

Model	MD-CCM02
Dimensions(HxWxD)(mm)	120x120x15
Power (V)	198-242V(50/60Hz)

Network Control Software & Gateways



Network Control Software & Gateways



IMM(Intelligent Manager of TGM) 4th Generation Network Control System



IMM software



M-interface Gateway

Intelligent Manager of TGM is designed specifically to control VRF systems. Based on a centralized format, it controls and monitors all the system's functions. It can be used as a flexible multi-purpose system and applied to meet various requirements according to the scale, purpose, and control method of each building.

Key Features >>

- ❖ Up to 4 M-interface gateways, 64 refrigerant systems, 1,024 indoor units, and 256 outdoor units can be controlled by one PC.
- ❖ User friendly operation
- ❖ Web access for M-interface gateway
- ❖ Central building monitoring and control
- ❖ Energy saving management
- ❖ Zone management
- ❖ Warning message
- ❖ *SMS modem(optional)
- ❖ Electricity charge distribution
- ❖ Annual schedule management
- ❖ Low-load operation indicator
- ❖ Generate operational history reports (daily, weekly)
- ❖ Fault display & Warning message
- ❖ Clean filter reminder
- ❖ Emergency stop and Alarm signal output
- ❖ Multiple languages



Web Access function



Energy Saving Management



Schedule management



Visual Navigation



Warning Message



Data Backup



Multiple Languages



Electricity Charge Distribution

Network Control Application >>

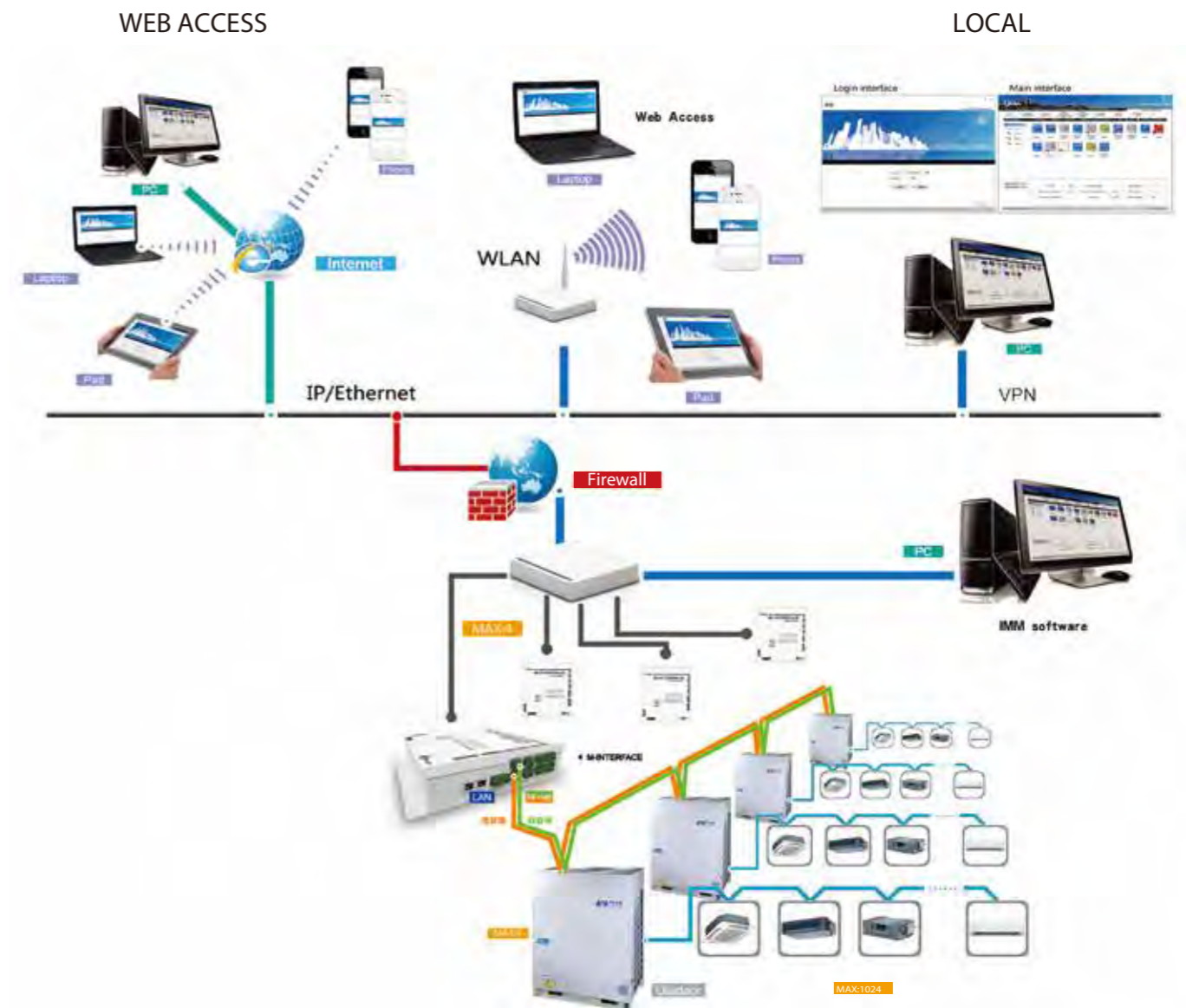

- ❖ Can run on Window 7_32/64 bit, Window XP_32 bit and Window 8.
- ❖ Can monitor and control A/C anytime, anywhere by PC, iPhone, iPad and notebook computer.
- ❖ Support WEB access: IE, Firefox, Safari and Chrome.
- ❖ Enables remote access through DSL, VPNs and so on.

Simple Operation & Management >>

- ❖ Click & Operate, a user-friendly interface allows non-experts to easily run the building management system.
- ❖ IMM offers a massive, flexible, and highly efficient centralized management program.

Login interface

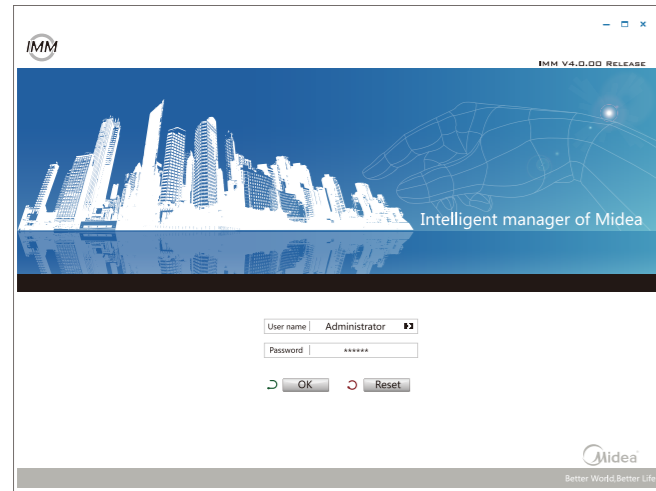

Main interface



Visual Navigation >>

Allows the floor plan to be imported. Dragging the A/C device to anywhere can locate the A/C quickly, and you can view it to specify the physical location of the A/C. With the visual navigation function, the layout of A/C is showed on the floor plan directly and the running solution is clear.



Web Access Function >>

With the web access function, a PC, laptop or a smart phone can be used as a remote controller. The function supports up to four users online at the same time. Connects with LAN and WAN so you can monitor and manage the A/C device remotely.

*WAN access needs to set up the VPN.

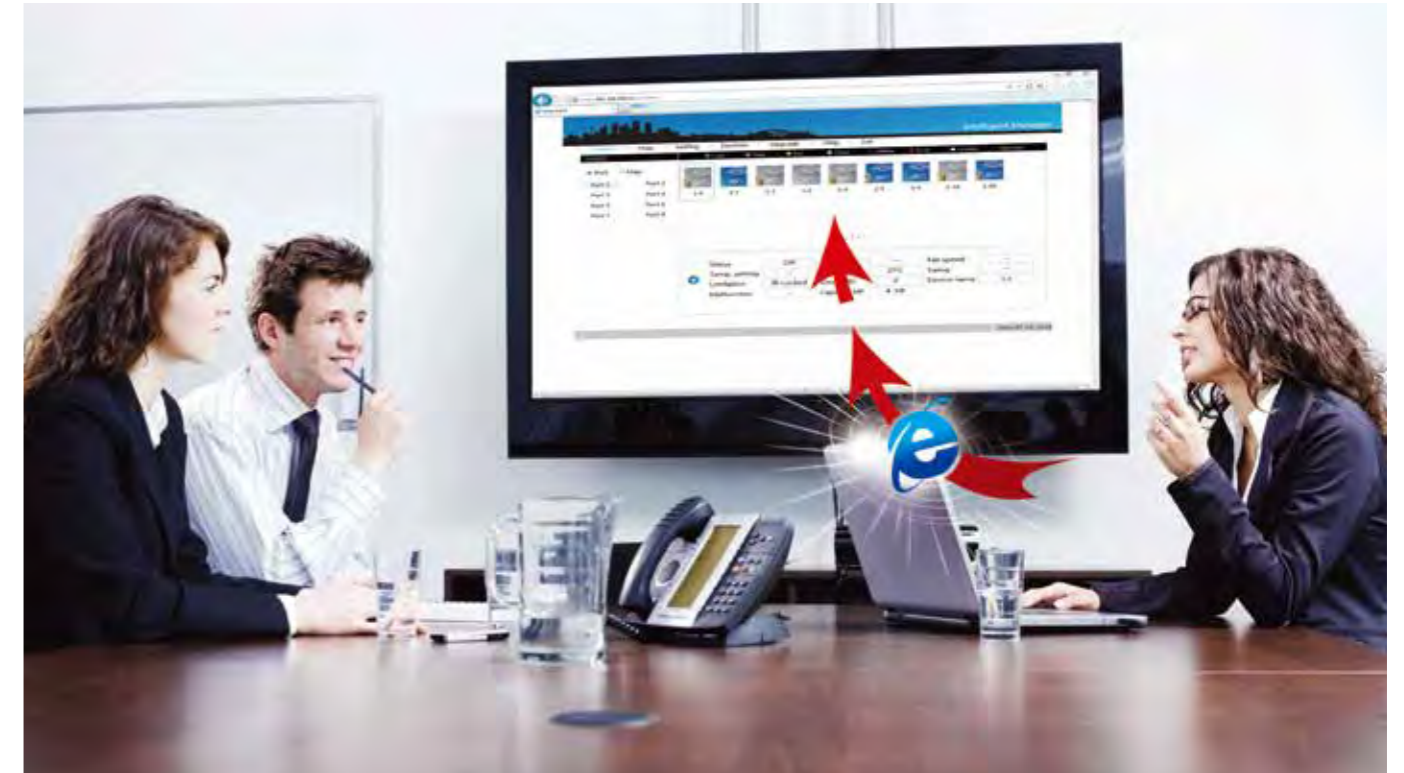

Schedule Management >>

Automatically performs facility start/stop control, switches the operating mode, sets temperatures and enables/disables the remote control according to the present time schedule.

- ◆ Users can set up day/week task for running periodically.
- ◆ Users can choose indoor units and assign task times as required.
- ◆ Except for the conventional setup, the system offers all kinds of energy conservation options.



Electricity Charge Distribution (Patented) >>

- ❖ Provides information on proportional electrical power distribution to optimize electricity consumption management.
- ❖ Uses software to calculate electric power proportional distribution. The software also outputs and saves electricity consumption data for each indoor unit (or group) connected to the intelligent manager.
- ❖ Applies the patented TGM Calculation Method to calculate consumption rates according to the capacity demand based on various parameters: temperature setting, room temperature, running mode, rated HP, public areas, unused rooms, and nighttime use. It outputs this information on a charge calculation sheet to evenly divide power consumption charges among tenants.
- ❖ Electricity charges can be easily divided when billing users for air conditioning power charges; for example, for tenants in a commercial building, offices in a rented building or rooms in a hotel.

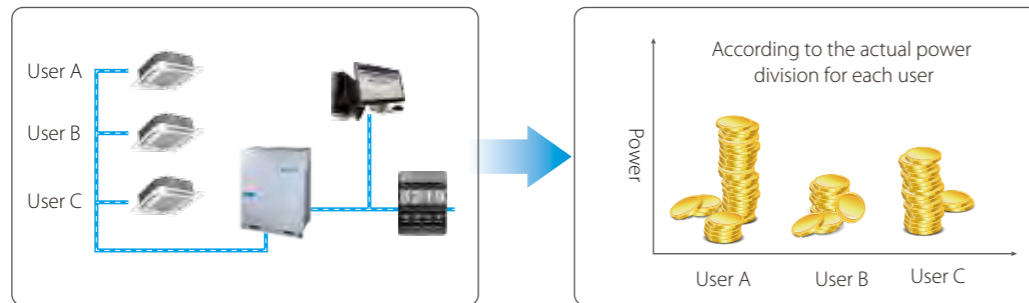

Energy consumption can be divided according to the running time, set temp, return air temp, and refrigerant flow.

Energy Saving Management >>

Based on a predetermined schedule, the Intelligent Manager executes capacity control and intermittent operations on all air conditioning units to maintain a high comfort index.

User can set a limit on any running unit, any parameter, such as cooling temp., heating temp., fan speed, operation mode, and so on.

- * 1. Meet with the <Public building energy efficiency management regulations>.
2. Matches the corresponding indoor units.

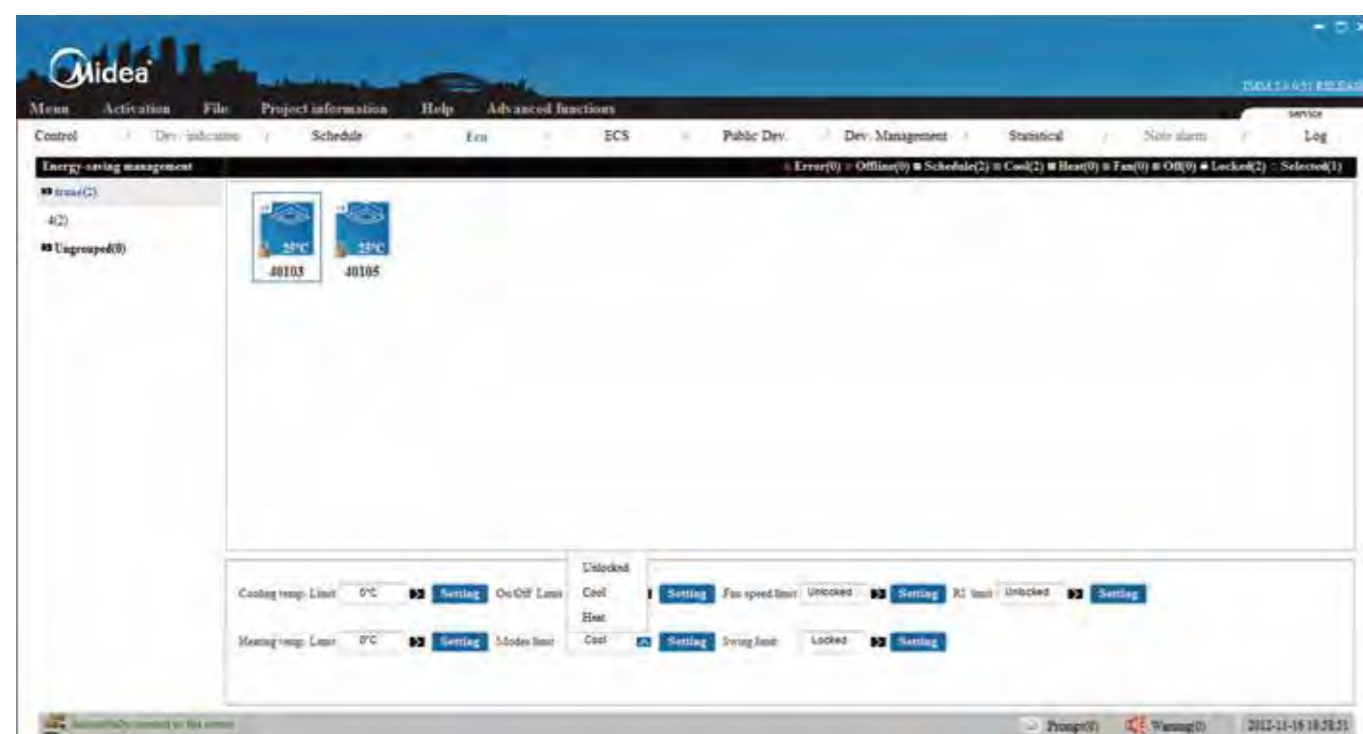

Automatic & Manual Topology >>

With automatic topology mode and manual topology mode.



Can topologize automatically between the indoor and outdoor units in the refrigerant system.
One M-interface gateway can support, up to 4 refrigerant systems, 256 indoor units and 16 outdoor units.



Manually set the topologize method between the indoor and outdoor units in the refrigerant system.
One M-interface gateway can support, up to 16 refrigerant systems, 256 indoor units and 64 outdoor units.

Warning Message >>

The system can receive error messages from air conditioning units in more than one building on public phone lines. If a particular factor influences normal operations, the system will send a message to technicians as an early warning.

*Requires the TGM "SMS Modem" to send automatic warning messages to designated phone numbers.

Data Management >>

Monitors the operating information of individual indoor units to distribute the power consumption of outdoor units.

Stores operation data on multiple systems and reports it in excel format for visual management.

Uses IMM software to generate tenant reports and help building owners bill for energy use.

Zone Management >>

Easy to control and manage air conditioners.

Easy to manage the energy charges of public devices.

Data Backup >>

Double data backup stored on the M-interface and IMM database.

The M-interface gateway automatically backs up power data for 1 or 2 months if a system failure occurs.

Examples: if there is a PC power failure or a system crash, the M-interface will automatically backup the data to the gateway.

IMM software also stores running data on the software database.

Colorful Language Obtained >>

Supports multiple languages. Customers can select their required language.

9 different languages:



Data Converter

The cloud server controller enables remote control on the VRF system through the Internet.

Smart phones, tablets, laptops, and desktop PCs can serve as a web controller for up to 64 indoor units.

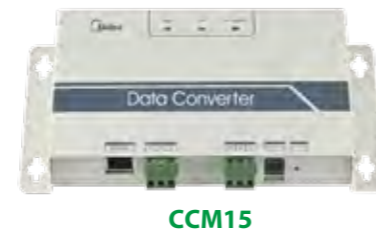

Network Example >>

Can directly connect to the XYE port of indoor/outdoor units.

Can connect up to 64 indoor units.

CCM03/CCM30 is optional, and can be connected with CCM15 through F1F2E ports.

The system comprises an A/C system, data converter CCM15, router, cloud server and control terminal.

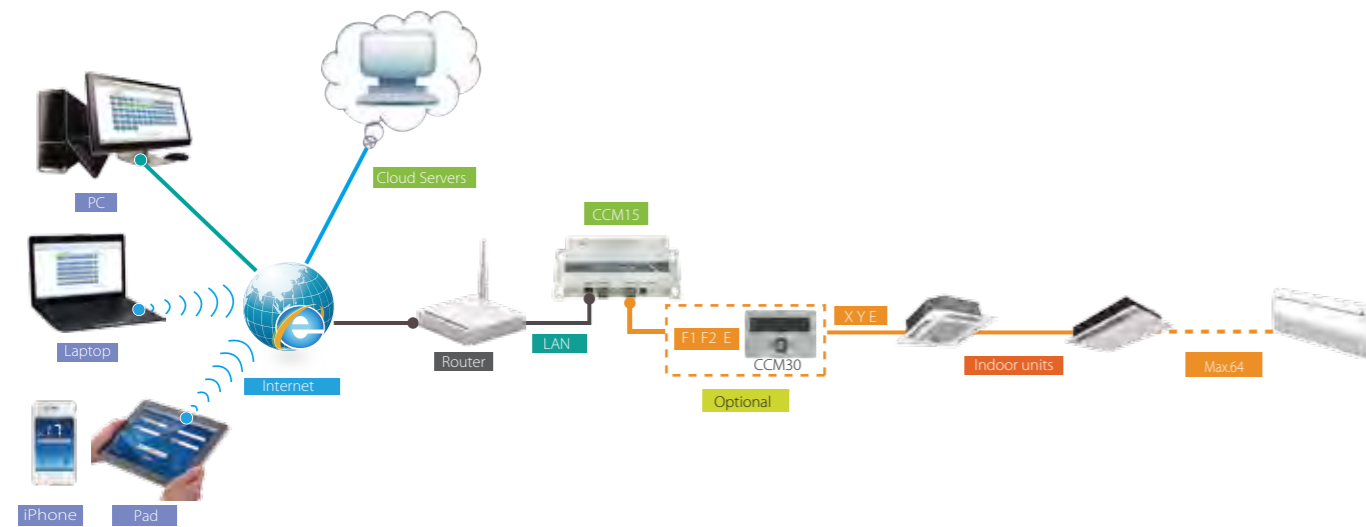

*If it connects to the XYE ports of the master ODU, the ODU must be set to auto addressing mode.

Simply Control Interface >>

Software control/ Cloud server control (WEB access).

Click & Operate: the user-friendly interface.

Allows single and group control.

Simplified user control interface.

Color indication and icons makes it easy to recognize unit status.

Includes a full-screen display, and allows temperature adjustment by swiping.



Weekly Schedule Control >>

Weekly schedule for iPad and Web function.

Multiple sections in each day for a single unit or group.

Automatically performs facility start/stop control, operating mode, and temperature according to the set time schedule.



Cloud Server Web >>

Query and control a single unit or group.

Weekly schedule setting: can set multiple sections in each day for a single unit or group.

Group user control: you can use the same ID to manage hundreds of CCM15 when you select the As group user button on the login page.

Historical errors: easy service and management with a history error function.

Intelligent Control >>

The air conditioner can be remote controlled by a phone or tablet.

Query and control the running state of the A/C anytime, anywhere, and schedule queries and actions in advance.

Remotely turn off the air conditioner to avoid wasting power.



Modbus® Gateway

LonWorks® Gateway

BMS

BACnet® Gateway

KNX Gateway

What is the BMS? >>

The Building Management System (BMS) (or Building Automation System (BAS)) is a computer-based control system installed in buildings. The BMS monitors the mechanical and electrical equipment such as ventilation, lighting, power, fire, and security. There are four types of common BMS protocols: BACnet, LonWorks, Modbus and KNX.



MD-KNX

KNX Gateway

Specially designed to allow monitoring and bidirectional control on the parameters and functionality of the TGM air conditioner from KNX installations

What Is The KNX? >>

KNX (Konnex) starts from 1999. KNX is the only global standard for housing and building control, and has been adopted by 70% of Europe's smart home market.

Key Features >>

- ❖ Compatible with all TGM VRF products.
- ❖ External power is not required and direct connect to the KNX EIB bus
- ❖ Fully KNX interoperable, configuration from ETS
- ❖ Multiple objects for control (different types: bit, byte, characters...)
- ❖ Easy installation and directly connects with one indoor unit through the RS485 bus
- ❖ Directly connects to the KNX bus
- ❖ KNX certification

Widely Applied >>

TGM KNX protocol gateway can be combined with hundreds of KNX certified products labeled with the KNX trademark in the same working system.

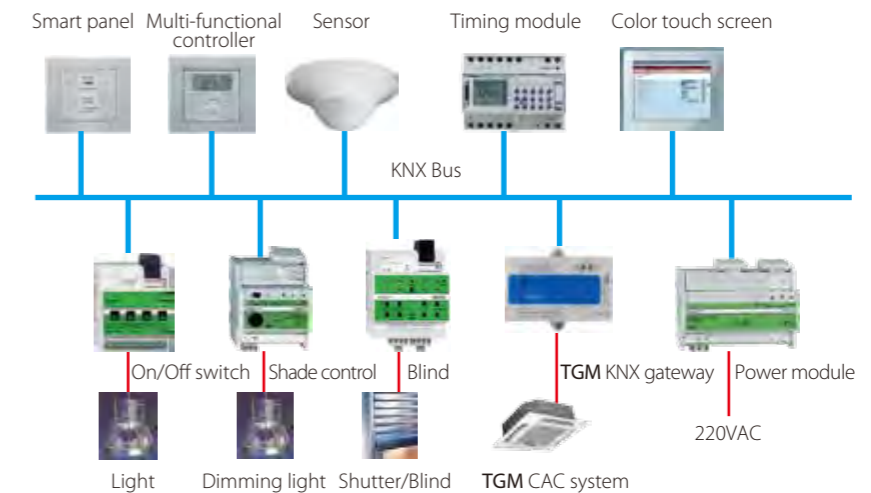

Electrical Wiring >>

One gateway only can be connected to one indoor unit.
Can only connect to the XYE port of the indoor unit.

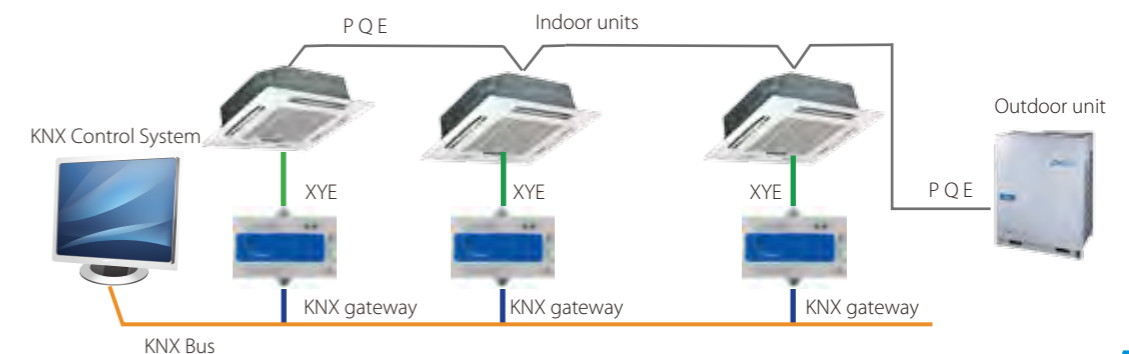

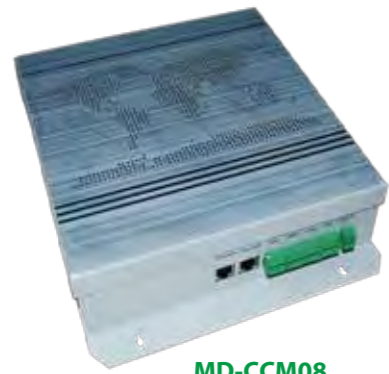

MD-CCM08

BACnet® Gateway

Integrated Control System for Seamless Connection between VRF and BMS Systems

What is the BACnet? >>

BACnet is a communications protocol for building automated control networks. BACnet was designed to allow building automation and control systems for applications to communicate; e.g., heating, ventilation, air conditioning control, lighting control, access control, and fire detection systems and their associated equipment.

Key Features >>

- ❖ Precise and efficient monitoring and control of the TGM VRF system
- ❖ Connect up to 256 indoor units or 128 outdoor units to the BMS
- ❖ Choose whether or not to connect to the BMS
- ❖ Built-in WEB function
- ❖ BTL certification

● Controlling

- Operation mode setting
- Temperature setting
- Fan speed setting
- Swing running for web
- Lock remote controller

● Monitoring

- Operation mode status report
- Set temperature status report
- Fan speed status report
- RC locking status
- Online quantity
- Timer status
- Error status
- Room temperature display

*For more information, refer to the product object table.

Monitoring Units Online >>

MD-CCM08 allows users to track units' running status and change their running parameters on Internet Explorer for maximum control convenience.

Quick & Easy Installation >>

Each port can connect to IDU/ODU XYE ports or outdoor units' K1K2E ports.
Each port can also connect to one CCM03 or one CCM02 through F1F2E ports.

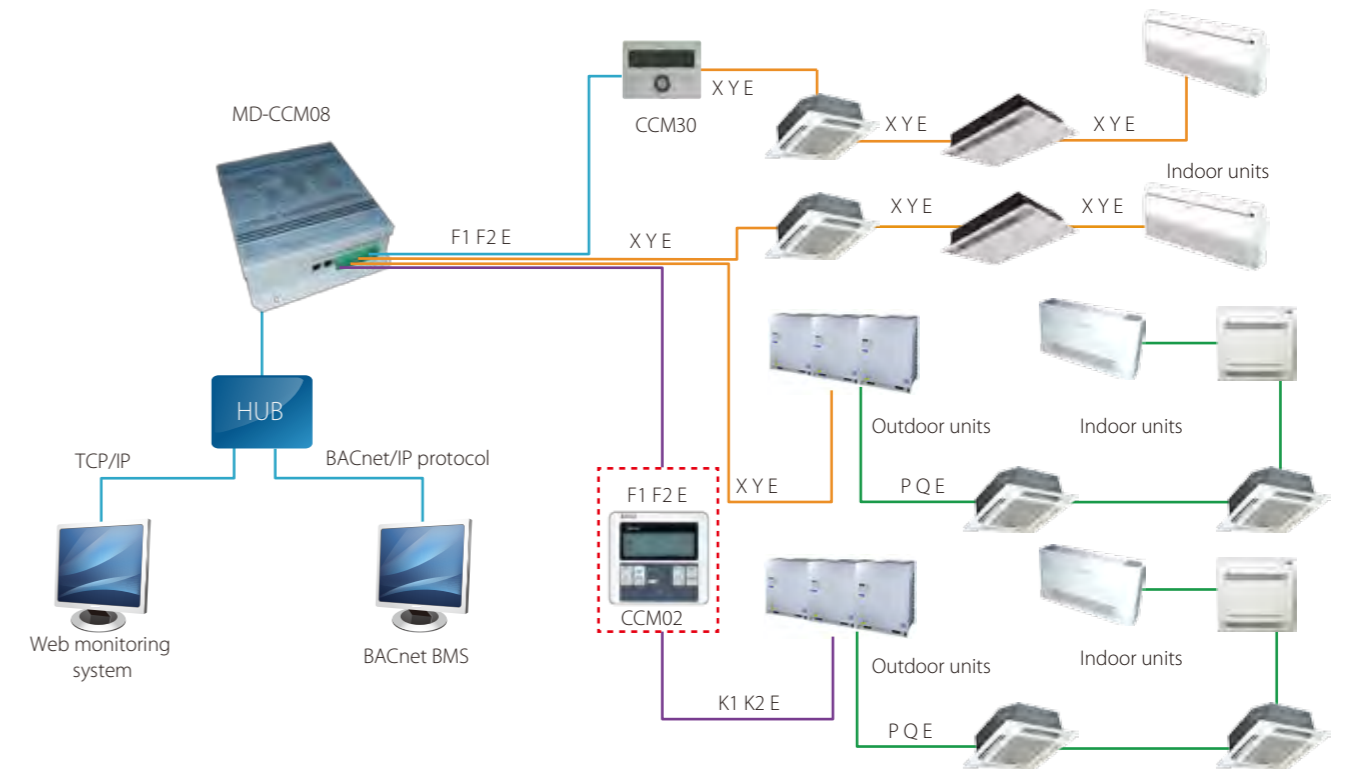

*If it connects to XYE ports of the master ODU, the ODU must be set to auto addressing mode.

Wide Compatibility >>

CCM08 adapts very well to the BMS

	Company	BMS software	Brand
1	SIMENS	APOGEE	
2	TRANE	Tracer Summit	
3	Honeywell	Alerton	
4	Schneider	Andover	
5	Johnson	METASYS	

Specifications

Model	MD-CCM08
Power supply	AC 220V~50/60Hz
Dimensions (HxWxD)(mm)	319x251x61



LonGW64

LonWorks® Gateway

Open network integration of VRF Monitoring and control functions into LonWorks networks

What is the LonWorks? >>

LonWorks (local operating network) is a networking platform specifically created to address the needs of control applications. The platform is built on a protocol created by Echelon Corporation for networking devices over media such as twisted pairs, power lines, fiber optics, and RF.

LonWorks networks are recognized worldwide as the de facto standard within the building control industry. LonWorks is used to automate various functions within buildings; e.g., energy management, fire / life / safety lighting and HVAC.

Key Features >>

- ❖ Connect to use LonWorks® protocol and TGM air conditioner protocol
- ❖ Compliance with LonMark protocol enables the management and control of A/C system
- ❖ Control various types of equipment from the customer's own PC
- ❖ Connect up to 64 indoor units to the BMS
- ❖ Option for large projects
- ❖ Easy and fast installation

● Controlling

- On/Off command
- Operation mode setting
- Temperature setting
- Fan speed setting

● Monitoring

- Operation mode status report
- Set temperature status report
- Fan speed status report
- Online/offline status
- Online quantity
- Error status
- Room temperature display

*For more information, refer to the product network's variable charts.

Network Example >>

- ❖ Connection method 1: suitable for all air conditioning systems and can connect up to 64 indoor units.

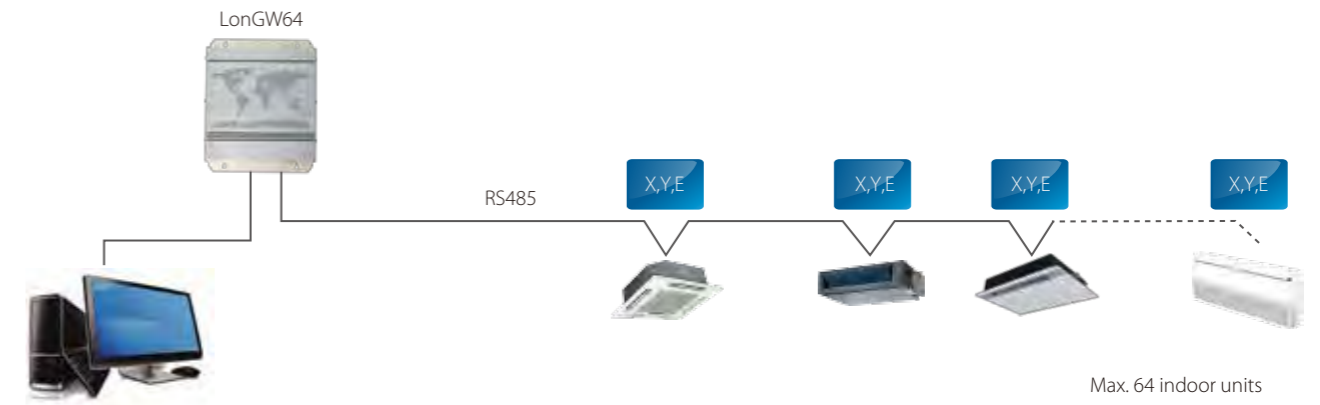

LonWorks BMS

- ❖ Connection method 2: only suitable for the V4 plus system and can connect up to 64 indoor units.

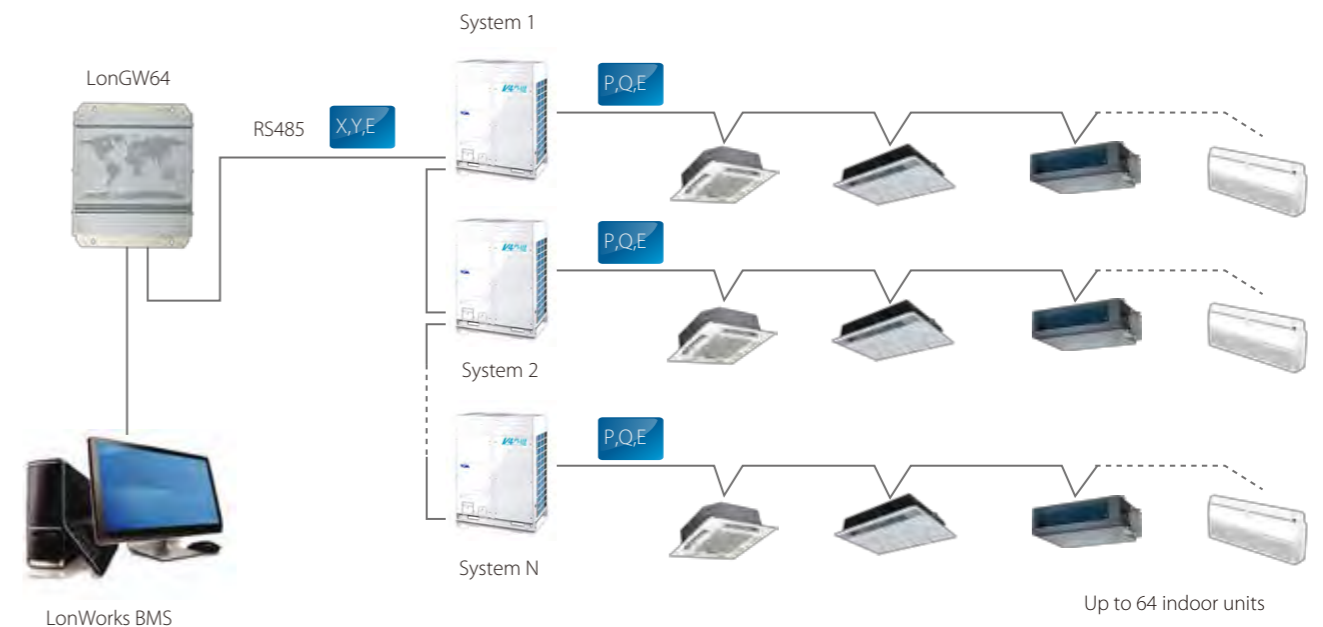

*If it connects to X,Y,E ports of the master ODU, the ODU must be set to auto addressing mode.

Specifications

Model	LonGW64/E
Power supply	AC 220V~50/60Hz
Dimensions (HxWxD) (mm)	319x251x61



CCM-18A

Modbus® Gateway

Integrated Control System for Seamless Connection between VRF and BMS Systems

What is the Modbus? >>

Modbus is a serial communications protocol originally published by Modicon (now Schneider Electric) in 1979 for use with its programmable logic controllers (PLCs). Modbus is often used to connect a supervisory computer with a remote terminal unit (RTU) in supervisory control and data acquisition (SCADA) systems.

Key Features >>

- ❖ Supports Modbus protocol networks
- ❖ Bridges the TGM central A/C system to the BMS
- ❖ Built-in WEB server function
- ❖ Connect to the BMS system through TCP/IP or RTU
- ❖ Connect up to 16 indoor or 64 indoor units and 4 outdoor units

*The four outdoor units must be in the same system

● Controlling

- Operation mode setting
- Temperature setting
- Fan speed setting

● Monitoring

- Operation mode status report
- Set temperature status report
- Timer status
- Fan speed status report
- RC locking status
- Online/offline status
- Error status
- Room temperature display

*For more information, refer to the Modbus product mapping table.



Config A/C System Via Web >>

When the Modbus network is set, users can conveniently configure their A/C network system online using different TCP/IP browsers.

Network Example >>

1) TCP connection method



2) RTU connection method

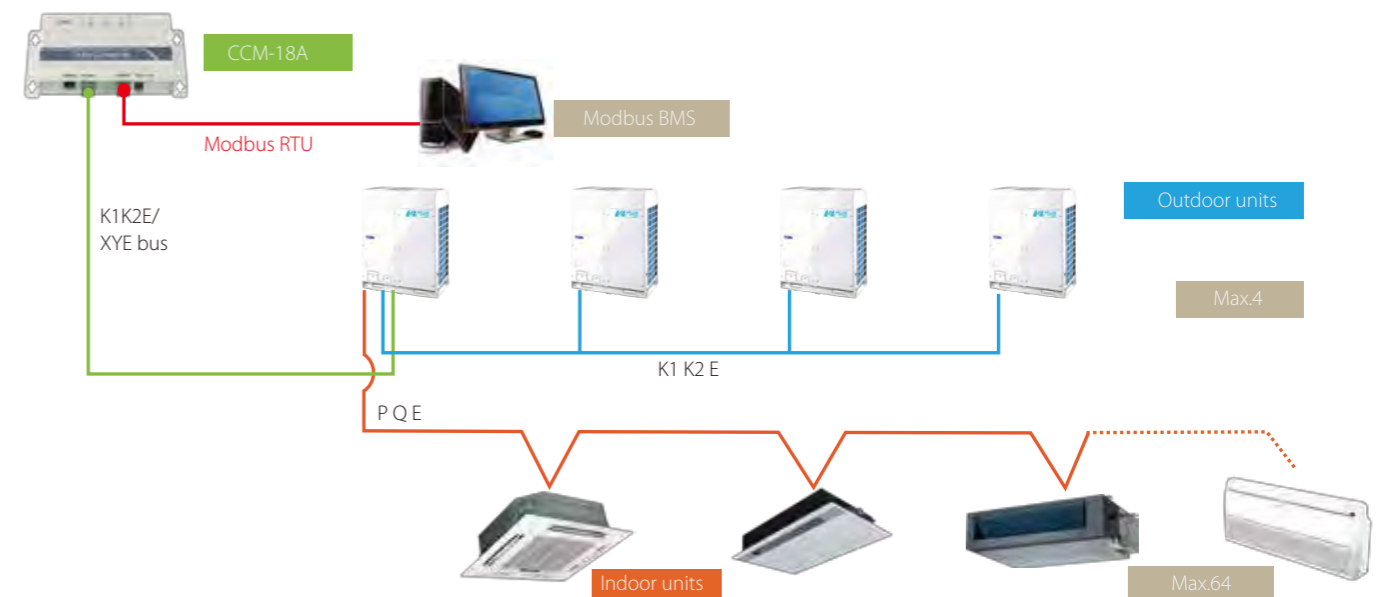

*1. If it connects to XYE ports of the master ODU, the ODU must be set to auto addressing mode.

2. XYE and K1K2E must be connected hand by hand.

Specifications

Model	CCM-18A
Dimensions (HxWxD)(mm)	319x251x61
Power supply	AC 220V~50/60Hz

Accessories



Hotel Key Card Interface Module



MD-NIM05/E



MD-NIM05B/E

Key Features >>

- ❖ MD-NIM05 is specially designed for hotel guest rooms, restaurants and so on. It works with a hotel card system
- ❖ Simple, compact, and easy to operate; suitable for hotel rooms
- ❖ Key card cooperates with wired controller to control the A/C
- ❖ Eliminates the need for high voltage power, making the device safe and reliable
- ❖ Includes a build-in auto-restart function
- ❖ Remote controller or wired controller can control indoor units
- ❖ Two types are available: MD-NIM05/E and MD-NIM05B/E

Application Example >>

The unit can be turned on or off when inserting or removing the key card.

When the key card is in place, the air conditioner is activated. When the key card is removed, the system can remember the previous setting and stop operation. If the key card is reinserted, the unit enters standby or runs in the same state as the previously. It can stop cooling an unoccupied room to save energy.

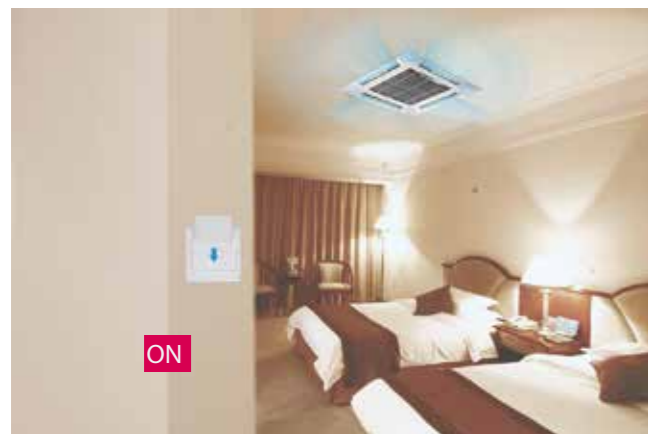

Installation Example >>

Easy installation and remote controller or wired controller can control indoor units.

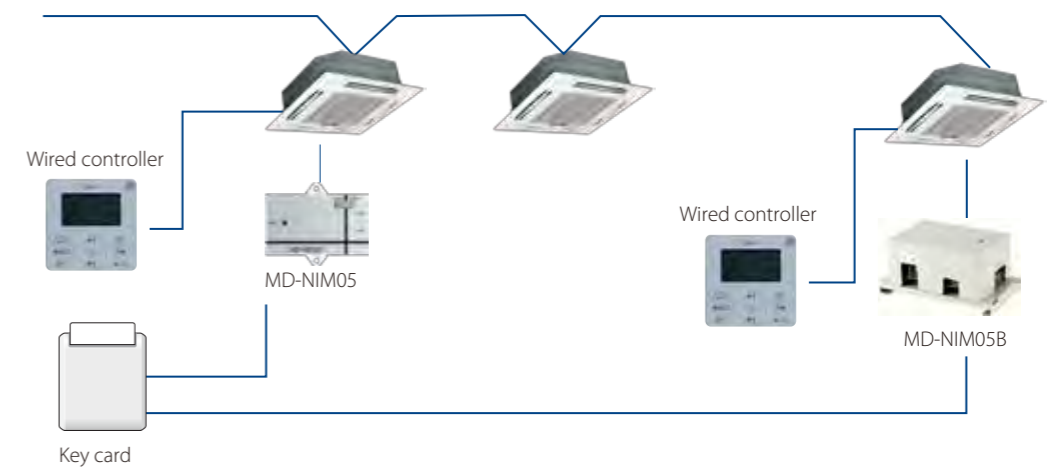

Electrical Wiring >>

For MD-NIM05/E, users need to buy a high voltage relay for installation.

For MD-NIM05B/E, it can be directly connected to the hotel card-insert system (AC 220V) without a high voltage relay.

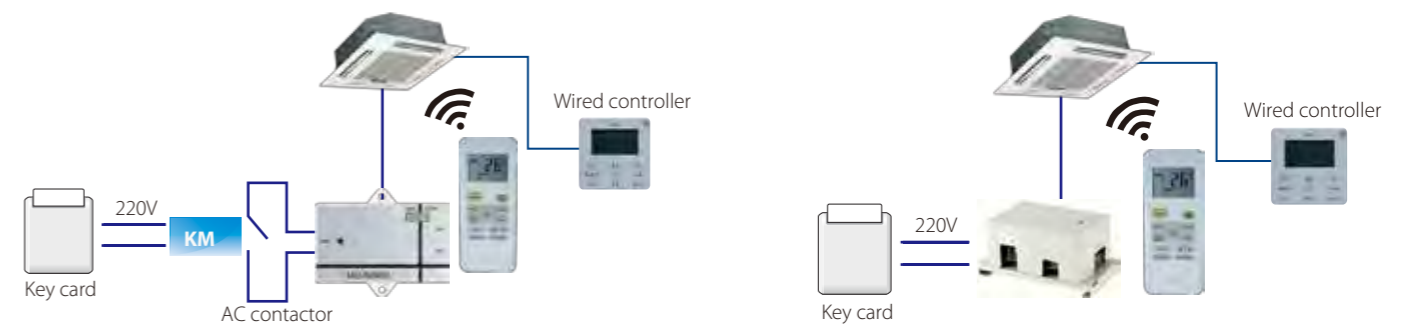

Specifications

Model	MD-NIM05/E	MD-NIM05B/E
Dimensions (HxWxD) (mm)	15.5x86x72.8	87x150x70
Power (V)	DC 5V (Supplied by indoor unit)	AC 220V

Infrared Sensor Controller

Infrared sensors can induct human activities in certain areas. Indoor units will be automatically turned on or off by sensing if the room is unoccupied.

It is suitable for hotels, offices, conference rooms, residences, etc.

- ❖ Automatically adjusts the room environment.
- ❖ Automatically extends the shut down time to avoid frequent ON/OFF.
- ❖ Stylish appearance accommodates itself to different buildings.



MD-NIM09

Accurate & Comfortable Sensor >>

It detects motion and automatically starts the air conditioner if motion is detected.

This function will save energy since it minimizes unnecessary energy usage by powering off when the area is empty.

The infrared sensor can be installed on the ceiling or wall of well-used areas.



Install on the ceiling

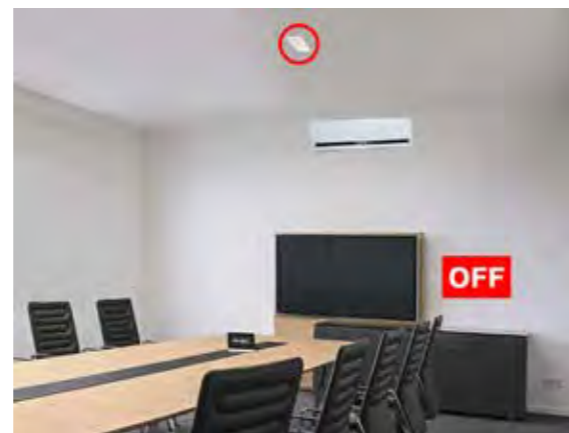

Installation Example >>

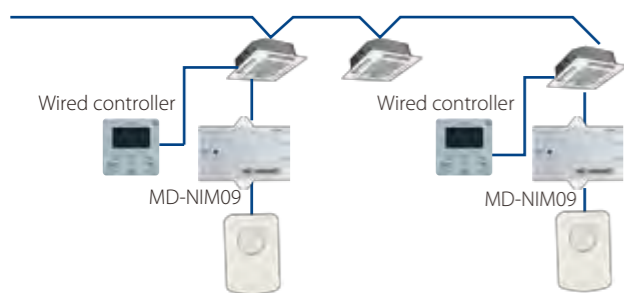

Remote controller or wired controller can control indoor unit.

Electrical Wiring >>

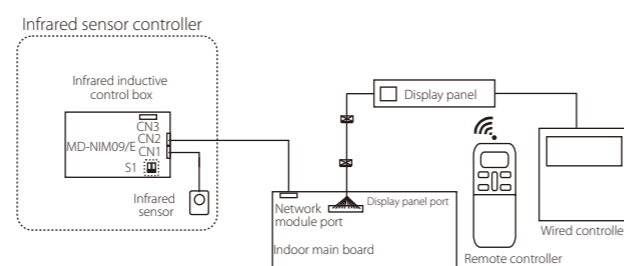

Specifications

Model	MD-NIM09
Dimensions (HxWxD)(mm)	Sensor part: 46x30x25.6, Control box: 86x72.8x15.5
Power	DC 5V (Supplied by indoor unit)

3-Phase Protector

HWUA/DPB71CM48

Detects power status and takes protective action to stop the compressor from being damaged.

Automatically distinguishes abnormal power supply conditions and automatically recovers.



Excellent Reliability >>

The protector protects the entire system from power supply problems, and auto restarts after recovery.

Specifications

Model	With over/under voltage function				Without over/under voltage function
	HWUA	DPA53CM23	HWUA	DPB71CM48	DPA51CM44
Power supply	220~480V-3N 50/60Hz	208~480V-3N 50/60Hz	220~480V-3N 50/60Hz	380~480V-3N 50/60Hz	208~480V-3N 50/60Hz
Temp. range	-20°C~50°C	50Hz: -20°C~60°C 60Hz: -20°C~50°C	-20°C~50°C	-20°C~50°C	50Hz: -20°C~60°C 60Hz: -20°C~50°C
Rated operational power	2.9 VA	7 VA	2.9 VA	13 VA	13 VA
Over voltage	12%	12%	18%	18%	/
Under voltage	-12%	-12%	-12%	-12%	
Phase imbalance	8%	/	8%	8%	
Dimensions(WxHxD)(mm)	90x69x35	81x67.2x17.5	90x69x35	81x67x35	81x67.2x17.5

Digital Power Ammeter

Calculates power consumption.

Does not need adjusting after long-term use.

Corresponds one outdoor unit to one digital power meter.



DTS634
DTS636

Low Power Consumption >>

The digital power meter consumes minimal energy.

Voltage circuit: less than 2W/10VA

Current circuit: less than 2.5VA

Indications & Installation >>

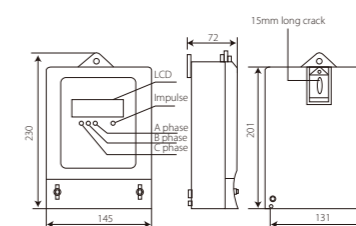

The digital power meter is tested after manufacture so it can be immediately deployed and used on-site. The LED indicators and installation schematic are shown in the figure on the left.

Specifications

Model	DTS634/DTS636
Dimensions (HxWxD)(mm)	230x145x72
Power (V)	200V-500V(50/60Hz)

Indoor Unit Group Controller



KJR-150A

Simple Design >>

KJR-150A is an indoor group controller designed specifically for V4 plus indoor units.

It can connect up to 16 indoor units through XYE ports.

With a display panel connected to KJR-150A, signals from a wired controller and remote controller can control a group of indoor units simultaneously. All indoor units will run at the same setting parameters. You can also control indoor units separately in each room by remote controller. The indoor units will run as previously set.

System Wiring Diagram >>

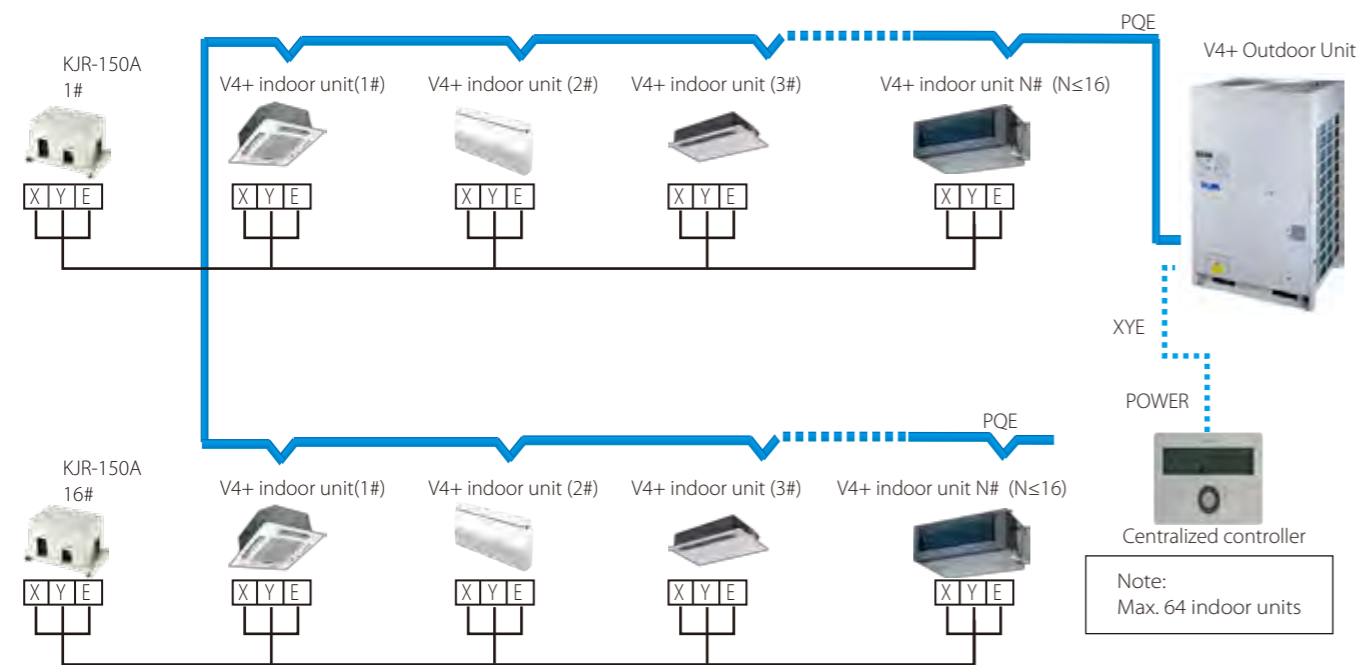

* If you need to use a centralized controller, you can connect to the XYE from an outdoor unit.

Specifications

Model	KJR-150A
Dimensions (HXWXD)(mm)	85X150X70
Power (V)	198-242V(50/60Hz)

Remote Alarm Controller



KJR-32B

Simple Design >>

KJR-32B is specially designed for engineering applications. It does not display the ODU's working parameters. However, it can connect to the alarm device when the ODU is working abnormally, in which case the RUN light will flash.

Specifications

Model	KJR-32B
Dimensions (HxWxD)(mm)	85X150X70
Power (V)	198-242V(50/60Hz)

Network Electricity Distribution Module



MD-NIM10

Simple Design >>

- ❖ External contact interface module
- ❖ Designed specifically for Mini VRF
- ❖ Provides the OAE ports for Mini VRF to connect with the IMM network control system, and distributes electricity across the network.

Wiring Diagram >>

OAE ports: connects to the OAE port of the ammeter.

PQE ports: connects to the PQE port of the outdoor unit.

Each port on M-interface gateway can only be connected with one MD-NIM10 through K1K2E ports.



AHU Control Box



AHUKZ-01A
AHUKZ-02A
AHUKZ-03A

AHUKZ-01B
AHUKZ-02B
AHUKZ-03B

Introduction >>

AHU Kit can be used to connect VRF outdoor units with DX AHU or other brand indoor units with AC fan motor. A Series and B Series are supplied. These can connect with the TGM VRF System (except V4+R& V5 Series). The A Series is an independent control box. For the B Series, up to four control boxes can be combined. The capacity reaches up to 224kW (80HP), and it's easy to create a solution for large projects.

Wiring Example >>

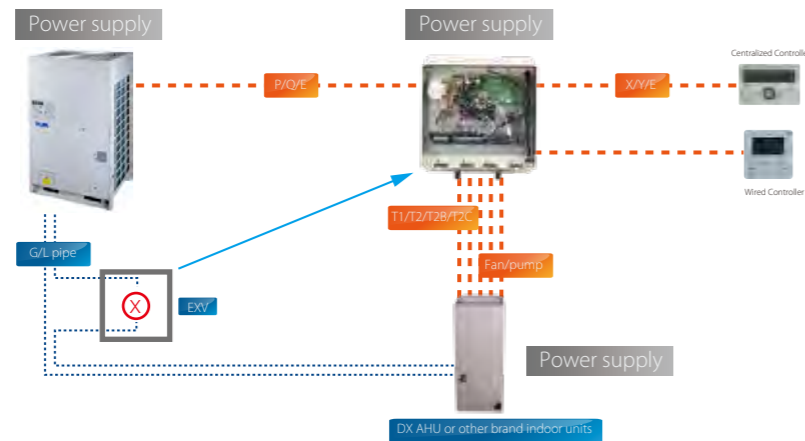

Specifications

Model	AHUKZ-01A/AHUKZ-02A/AHUKZ-03A AHUKZ-01B/AHUKZ-02B/AHUKZ-03B
Dimensions(HxWxD)(mm)	335x375x150
Power (V)	220-240V~ 50Hz 208-230V~ 60Hz

TGM Outdoor Unit Diagnosis Software

Display the outdoor units' real-time running conditions.
Automatically outputs running status charts.
Supports V3, V4, V4+, D3, D4, V4+S and V4+R outdoor units.

Wiring Diagram >>

The diagnostic software applies to K1, K2, E of the outdoor units. The corresponding wiring diagram is shown in the figure on the right.

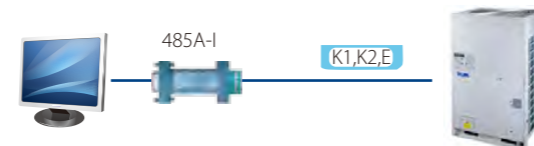

Recommended Config

Operating system	WIN XP SP4/WIN 7
CPU	Pentium 4 2G or above
HDD	30G free space
Interface port	RS-232 terminal

Selection Software

To meet consultants' and distributors' requirements, TGM has developed an advanced design automation tool that can be used in AutoCAD-based CAD version or Windows-based Sales version. The software provides quick and convenient selectable options for users, supports multiple languages, and greatly improves the selection process.

Windows Version >>

Load calculation: provides two calculation methods (detailed room load calculation and rough load calculation).
Indoor & outdoor units: choose from versatile indoor units and different outdoor units.
Piping drawing: displays the detailed layout of the A/C system and the parameters for piping and branch distributors.
Controller selection: provides a selection of controllers for indoor units and outdoor units, including wireless and remote controllers for indoor units.
Report output: outputs a comprehensive selection report as a Word or PDF document.

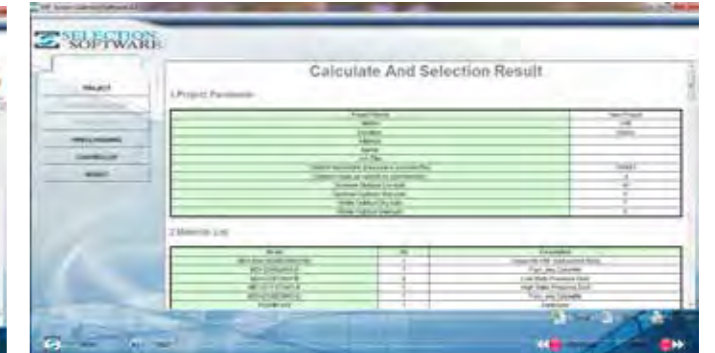

CAD Version >>

AutoCAD add-on software
Automatic Calculation: refrigerant & drain pipe size
Automatic Selection: distributor kit & branch joint
System Check: installation regulations & adding refrigerant
Automatic Report: piping installation diagram, equipment list & quotation

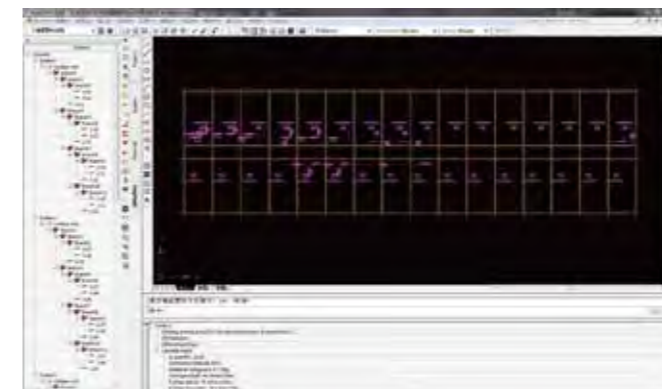

APP Application

TGM News APP >>

TGM News APP has been developed to share E-news, new product information, training information and product catalogs.



TGM CAC News Application



iOS Version

TGM After-service APP >>

TGM CAC After-service APP is very useful for engineers who serve for TGM commercial air conditioner. It will be very convenient to do the commissioning, refrigerant charge and troubleshooting.

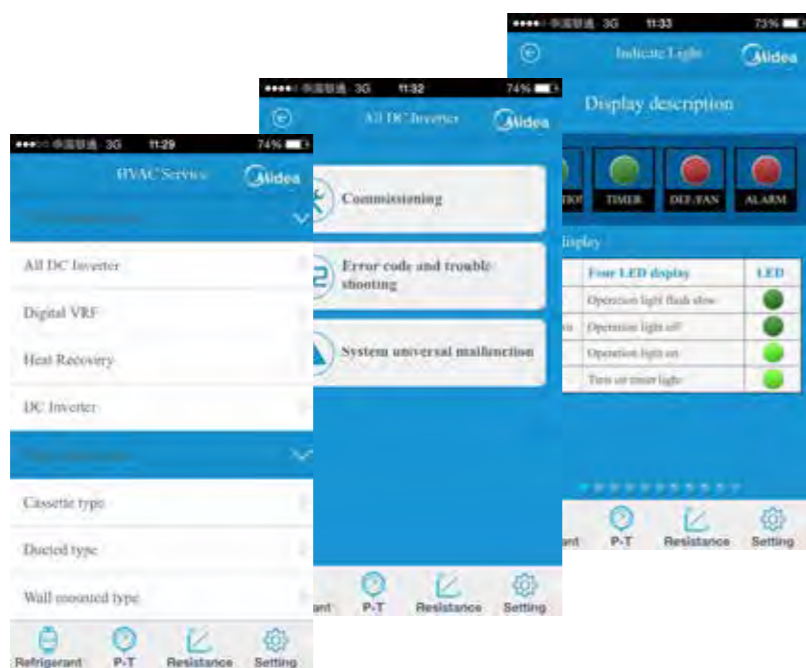

TGM CAC After-service Application



Android Version



iOS Version

HRV-Heat recovery ventilator

- Larger air supply rate
- enhanced heat exchange efficiency
- enhanced energy saving property >>

The heat recovery ventilator (HRV) can reclaim heat energy lost through ventilation and reduce the room temperature fluctuation caused by ventilation process. By utilizing the most advanced technology and technics, TGM HRV has extremely good performance. The heat exchanged core is made of special paper processed with chemical treatment, which could realize better temperature and humidity control of the room environment. Temperature exchange efficiency is above 65% and enthalpy exchange efficiency between 50-65%.

Model Names

- HRV-200
- HRV-300
- HRV-400
- HRV-500
- HRV-800
- HRV-1000



- HRV-1500
- HRV-2000

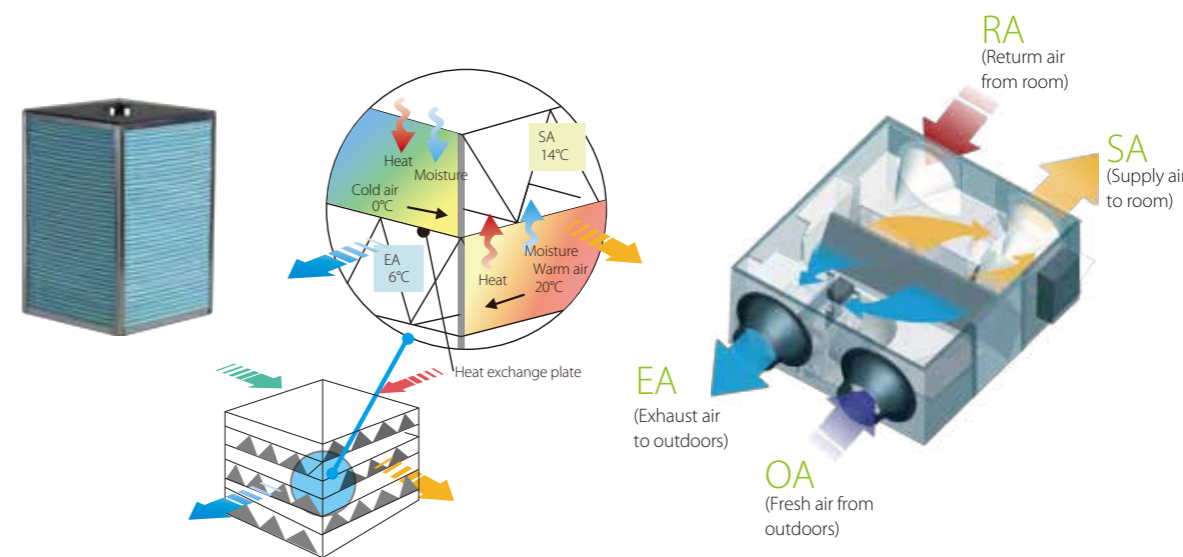

Low noise >>

Sound proof material is used to guarantee quiet operation.

Compact design, flexible installation and easy maintenance >>

With a min. height of only 10-25/64in.(264mm) and 50lbs(23kg) weight, the unit provides best convenience and possibility for installation in limited spaces.

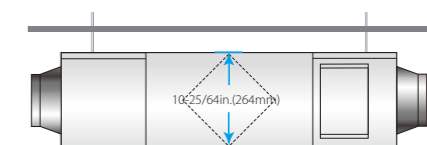

Multi-modes for different situations >>

Heat exchange mode

When air flow formed by the fans goes through the heat exchanged core in cross way, due to temperature difference between two channels of the core, thermal transmission happens naturally.

In summer days, high temperature outdoor air gets cooled by indoor exhaust air; in winter, low temperature outdoor air gets heated by indoor exhaust air. So the energy contained in exhaust air can be reclaimed and energy efficiency gets improved.

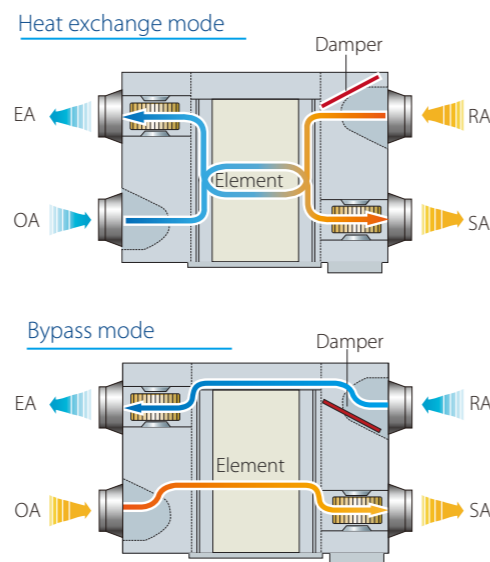

Bypass mode

In mild climate areas or seasons, when temperature and humidity level difference between indoor and outdoor is small, the unit works as conventional ventilation fan. Both supply fan and exhaust fan works at the same speed (Hi/mid/low/auto).

Air supply mode

It is one kind of bypass mode with air supply fan speed higher than exhaust fan speed. It can be used in mild climate area where large amount fresh air is needed.

Exhaust air mode

It is also one kind of bypass mode with exhaust fan speed higher than air supply fan speed. It can be used in mild climate area where large amount exhaust air needs to be expelled.

Auto mode

The controller chooses heat exchange mode or bypass mode according to the temperature difference between outdoor and indoor temperature. Both the two fans work at low speed.

Flexible control >>

Interlocking control with other indoor units by controller is possible.

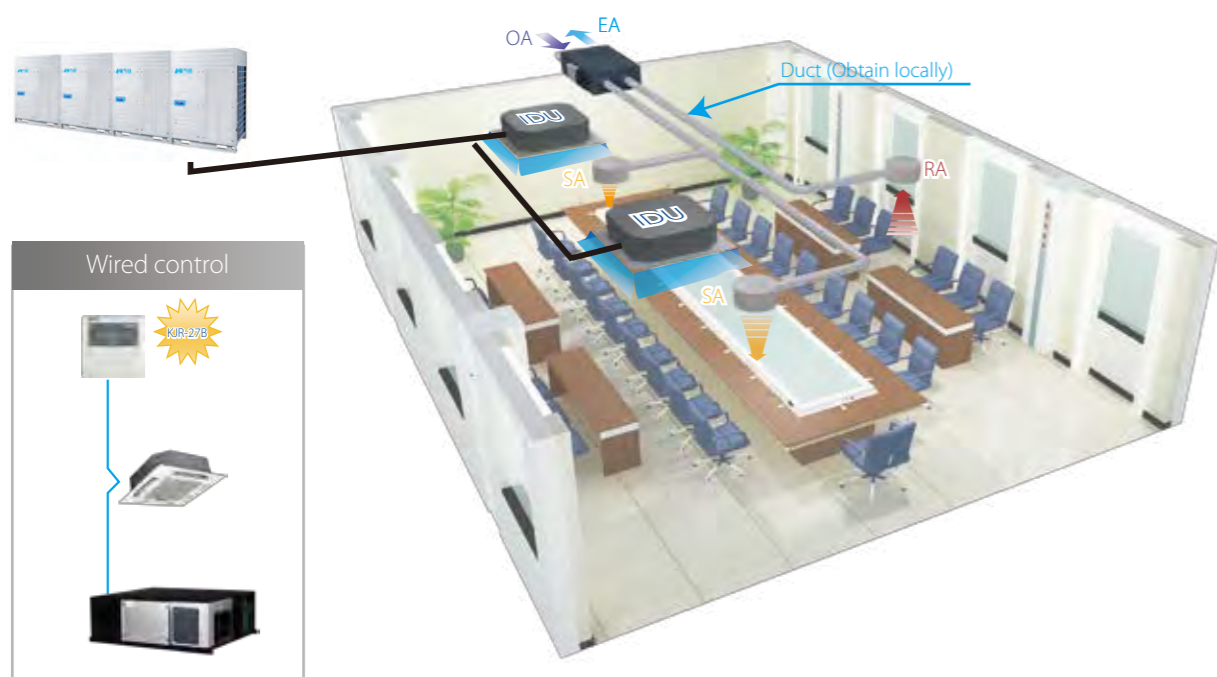

Specifications

Model				HRV-400	HRV-500	HRV-800	
Power supply				V/Ph/Hz	220/1/60	220/1/60	
Cooling	Temperature exchange efficiency	High	%	55	55	55	
		Medium	%	55	55	55	
		Low	%	60	60	60	
Enthalpy exchange efficiency	High	%	50	50	50		
	Medium	%	50	50	50		
	Low	%	55	55	55		
Heating	Temperature exchange efficiency	High	%	60	65	65	
		Medium	%	60	65	65	
		Low	%	65	70	70	
Enthalpy exchange efficiency	High	%	60	60	60		
	Medium	%	60	60	60		
	Low	%	65	65	65		
Sound pressure level	Heat exchange mode	High	dB(A)	32	35	39	
		Medium	dB(A)	31	34	38	
	Bypass mode	High	dB(A)	25	28	32	
		Medium	dB(A)	33	36	40	
Net dimension (WxDxH)				mm	944x927x270	1038x1026x270	
Packing size (WxDxH)				mm	37-3/16x36-1/2x10-5/8	40-7/8x40-3/8x10-5/8	50-5/8x39-5/8x15-1/4
Net/gross weight				kg(lbs)	31/52(68.3/114.4)	41/64(90.4/140.8)	54-5/16x43-5/16x22-9/16
Casing					Galvanized steel plate		
Heat exchange system					Air to air cross flow total heat (sensible heat + latent heat) exchange		
Heat exchange element material					Specially processed nonflammable paper		
Fan	Type	Centrifugal fan					
		Airflow rate	High	m ³ /h(CFM)	400(235.6)	500(294.5)	800(471.1)
			Medium	m ³ /h(CFM)	400(235.6)	500(294.5)	800(471.1)
	Low		m ³ /h(CFM)	300(176.7)	375(220.8)	600(353.4)	
	ESP	High	Pa	80	80	100	
		Medium	Pa	65	68	82	
Low		Pa	43	45	54		
Motor output	W		80	120	360		
Duct diameter				mm(in.)	Φ144(5-5/8)	Φ194(7-5/8)	
Operating temperature range				°C		-7~43 DB, 80% RH or less	
				°F		19.4~109.4 DB, 80% RH or less	

Model				HRV-1000	HRV-1500	HRV-2000	
Power supply				V/Ph/Hz	220/1/60	220/3/60	
Cooling	Temperature exchange efficiency	High	%	55	55	55	
		Medium	%	55	/	/	
		Low	%	60	/	/	
Enthalpy exchange efficiency	High	%	50	50	50		
	Medium	%	50	/	/		
	Low	%	55	/	/		
Heating	Temperature exchange efficiency	High	%	65	65	65	
		Medium	%	65	/	/	
		Low	%	70	/	/	
Enthalpy exchange efficiency	High	%	60	60	60		
	Medium	%	60	/	/		
	Low	%	65	/	/		
Sound pressure level	Heat exchange mode	High	dB(A)	40	51	53	
		Medium	dB(A)	39	/	/	
	Bypass mode	High	dB(A)	33	52	54	
		Medium	dB(A)	41	/	/	
Net dimension (WxDxH)				mm	1286x1256x388	1600x1270x540	
Packing size (WxDxH)				mm	50-5/8x49-7/16x15-1/4	63x50x21-1/4	65x57-7/8x21-1/4
Net/gross weight				kg(lbs)	1390x1350x580	1680x1350x720	1760x1580x720
Casing					Galvanized steel plate		
Heat exchange system					Air to air cross flow total heat (sensible heat + latent heat) exchange		
Heat exchange element material					Specially processed nonflammable paper		
Fan	Type	Centrifugal fan					
		Airflow rate	High	m ³ /h(CFM)	1000(588.2)	1500(882.4)	2000(1176.5)
			Medium	m ³ /h(CFM)	1000(588.2)	/	/
	Low		m ³ /h(CFM)	750(441.2)	/	/	
	ESP	High	Pa	100	160	170	
		Medium	Pa	85	/	/	
Low		Pa	58	/	/		
Motor output	W		360	450	450		
Duct diameter				mm(in.)	Φ242(9-1/2)	346x326(13-5/8x12-7/8)	
Operating temperature range				°C		-7~43 DB, 80% RH or less	
				°F		19.4~109.4 DB, 80% RH or less	

Note:

1. For the units model of HRV (400-1000), there are 3-speed adjustable air volume (Hi, Med, Low), but for the units model of HRV (1500-2000), there are only 1-speed which cannot be adjusted.

2. Sound level is measured at 1.4m below the center of the body in an anechoic chamber.



3. Efficiency is measured under the following conditions:

* Cooling Condition: Air Exhaust Temp. 27°C(80.6°F) DB, 19.5°C(67.1°F) WB, Fresh Air Temp. 35°C(95°F) DB, 28°C(82.4°F) WB.

* Heating Condition: Air Exhaust Temp. 21°C(69.8°F) DB, 13°C(55.4°F) WB, Fresh Air Temp. 5°C(41°F) DB, 2°C(35.6°F) WB.

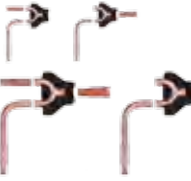
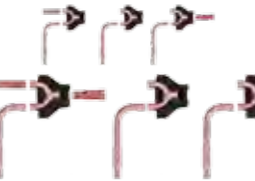

Branch Pipe

Branch joints of two-pipe refrigerant system

Model	Appearance	Model name	Packing Size in.(mm)	Gross Weight lbs.(kg)	Description
Branch joint for 410A outdoor unit		FQZHW-02N1D	10-1/16x5-7/8x7-1/4 (255x150x185)	3.3(1.5)	For two outdoor units connection
		FQZHW-03N1D	13-9/16x6-5/16x11-1/4 (345x160x285)	7.48(3.4)	For three outdoor units connection
		FQZHW-04N1D	18-3/4x6-1/2x11-3/4 (475x165x300)	10.56(4.8)	For four outdoor units connection
Branch joint for R410A indoor unit		FQZHN-01D	11-7/16x4-1/8x4 (290x105x100)	0.88(0.4)	A* < 16.6kW
		FQZHN-02D	11-7/16x4-1/8x4 (290x105x100)	1.32(0.6)	16.6 ≤ A* < 33kW
		FQZHN-03D	12-3/16x5-1/8x4-15/16 (310x130x125)	1.98(0.9)	33kW ≤ A* < 66kW
		FQZHN-04D	13-25/32x7-3/32x6-11/16 (350x180x170)	3.3(1.5)	66kW ≤ A* < 92kW
		FQZHN-05D	14-3/8x7-11/16x8-15/32 (365x195x215)	4.18(1.9)	92kW ≤ A*

A*:The total capacity of indoor units which is connected to this branch joint

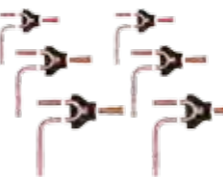
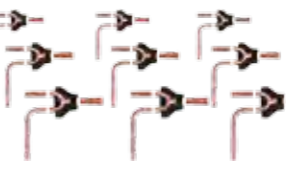
Branch joints of three-pipe refrigerant system

Model	Appearance	Model name	Packing Size in.(mm)	Gross Weight lbs.(kg)	Description
Branch joint between outdoor unit		FQZHW-02SB	10-11/16x6-9/16x9-1/8 (272x167x232)	4.84(2.2)	For two outdoor units connection
		FQZHW-03SB	18-9/16x6-3/16x12-9/32 (472x157x312)	11(5.0)	For three outdoor units connection
		FQZHW-04SB	29-5/16x6-5/16x13-3/16 (745x160x335)	16.5(7.5)	For four outdoor units connection
Branch joint between MS unit and outdoor unit		FQZHN-01SB	10-1/8x5x4-7/32 (257x127x107)	1.76(0.8)	A* < 16.6kW
		FQZHN-02SB	11-5/16x5-3/8x4-7/32 (287x137x107)	1.98(0.9)	16.6 ≤ A* < 33kW
		FQZHN-03SB	11-11/16x6-9/16x6-31/32 (297x167x177)	3.08(1.4)	33kW ≤ A* < 66kW
		FQZHN-04SB	14-5/8x7-3/4x7-3/8 (372x197x187)	5.06(2.3)	66kW ≤ A* < 92kW
		FQZHN-05SB	17-1/64x8-3/4x8-15/16 (432x222x227)	7.26(3.3)	92kW ≤ A*

A*:The total capacity of indoor units which is connected to this branch joint

Dimensions

Outdoor branch joints

Branch model	Gas side joints	Liquid side joints
FQZHW-02N1D		
FQZHW-03N1D		
FQZHW-04N1D		

Indoor branch joints

Branch model	Gas side joints	Liquid side joints
FQZHN-01D		
FQZHN-02D		
FQZHN-03D		
FQZHN-04D		
FQZHN-05D		